

### GENERAL DESCRIPTION

The **SP26LV431** is a quad differential line driver that meets the specifications of the EIA standard RS-422 serial protocol. The **SP26LV431** features Exar's BiCMOS process allowing low power operational characteristics of CMOS technology while meeting all of the demands of the RS-422 serial protocol over 60Mbps under load. The RS-422 protocol allows up to 10 receivers to be connected to a multipoint bus transmission line. The **SP26LV431** features a driver enable control common to all four drivers that places the output pins in a high impedance state. Since the cabling can be as long as 4,000 feet, the RS-422 drivers of the **SP26LV431** are equipped with a wide common-mode output voltage range to accommodate ground potential differences.

### FEATURES

- Quad Differential Line Drivers
- Compatible with the EIA standard for RS-422 serial protocol
- High-Z Output Control
- At Least 60Mbps Transmission Rates
- 11ns Typical Driver Propagation Delays
- Less than 1ns Typical Output Skew
- Single +3.3V Supply Operation
- Common Driver Enable Control
- Compatibility with the industry standard 26LV31
- Ideal For Use with SP26LV432, Quad Receivers

FIGURE 1. TYPICAL APPLICATION CIRCUIT

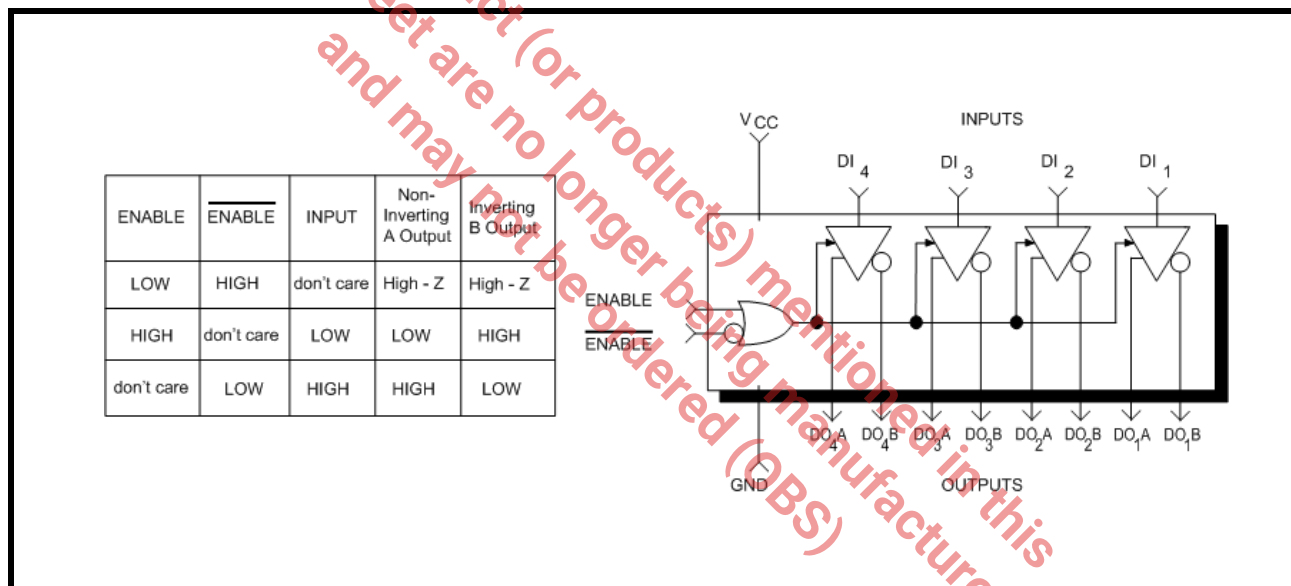
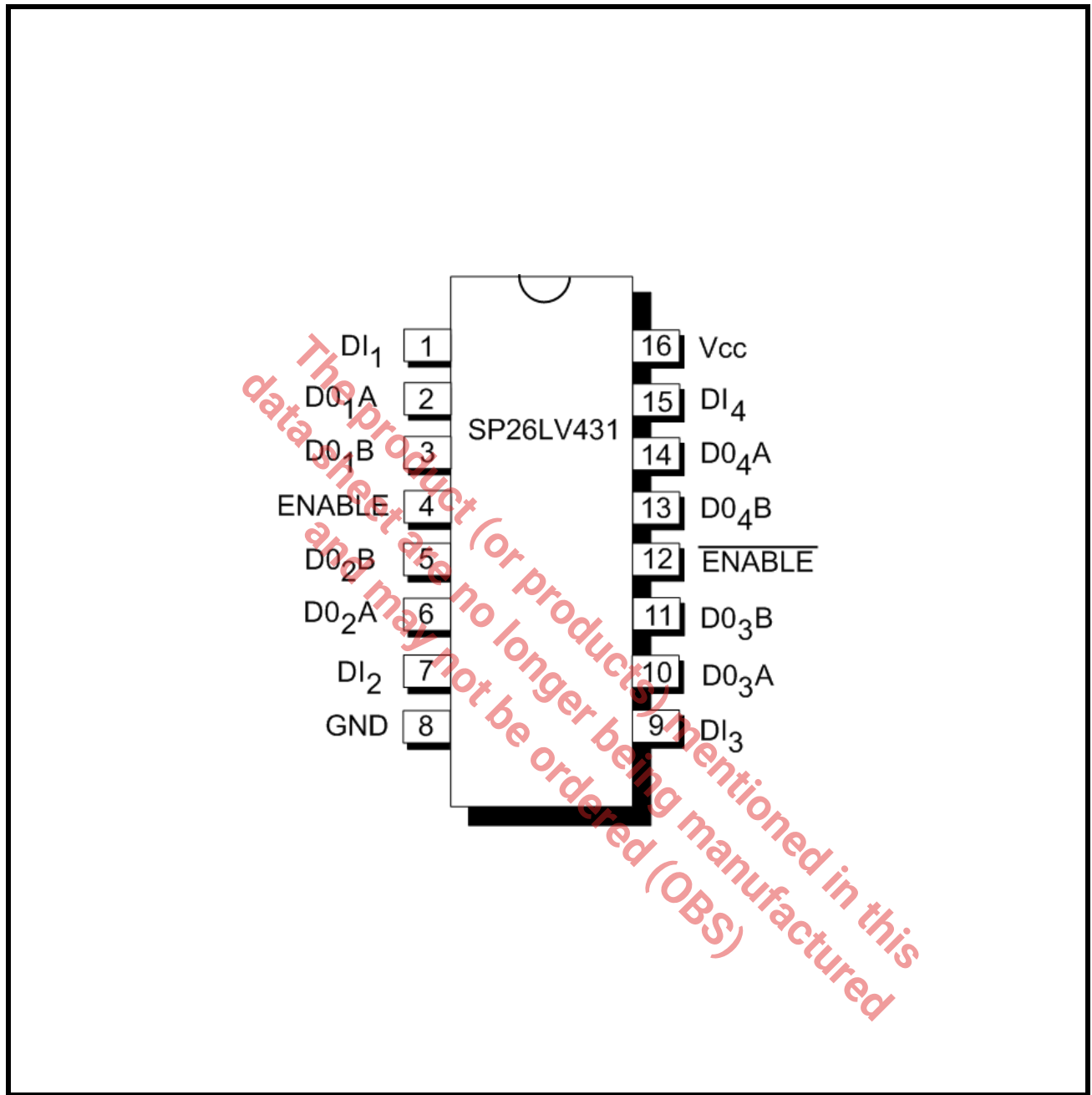

FIGURE 2. PIN OUT ASSIGNMENT



**ORDERING INFORMATION**

PART NUMBER	PACKAGE	OPERATING TEMPERATURE RANGE	DEVICE STATUS
SP26LV431CN-L	16-pin Narrow SOIC	0°C to +70°C	Active
SP26LV431CN-L/TR	16-pin Narrow SOIC	0°C to +70°C	Active
SP26LV431EN-L	16-pin Narrow SOIC	-40°C to +85°C	Active
SP26LV431EN-L/TR	16-pin Narrow SOIC	-40°C to +85°C	Active

**PIN DESCRIPTIONS****Pin Assignments**

PIN NUMBER	PIN NAME	TYPE	DESCRIPTION
1	DI <sub>1</sub>	I	Driver 1 TTL input.
2	DO <sub>1A</sub>	O	Non-inverted driver 1 output.
3	DO <sub>1B</sub>	O	Inverted driver 1 output.
4	ENABLE	I	Driver output enable, active HIGH.
5	DO <sub>2B</sub>	O	Inverted driver 2 output.
6	DO <sub>2A</sub>	O	Non-inverted driver 2 output.
7	DI <sub>2</sub>	I	Driver 2 TTL input.
8	GND	Pwr	Ground.
9	DI <sub>3</sub>	I	Driver 3 TTL input.
10	DO <sub>3A</sub>	O	Non-inverted driver 3 output.
11	DO <sub>3B</sub>	O	Inverted driver 3 output.
12	ENABLE	I	Driver output enable, active LOW.
13	DO <sub>4B</sub>	O	Inverted driver 4 output.
14	DO <sub>4A</sub>	O	Non-inverted driver 4 output.
15	DI <sub>4</sub>	I	Driver 4 TTL input.
16	V <sub>CC</sub>	Pwr	+3.0V to +3.6V power supply.

Pin type: I=Input, O=Output.

## ABSOLUTE MAXIMUM RATINGS

These are stress ratings only and functional operation of the device at these ratings or any other above those indicated in the operation sections to the specifications below is not implied. Exposure to absolute maximum rating conditions for extended periods of time may affect reliability and cause permanent damage to the device.

$V_{CC}$	0.5V to 7.0V
$V_{IN}$ (DC Input Voltage)	-1.5V to ( $V_{CC} + 1.5V$ )
$V_{OUT}$ (DC Output Voltage)	-0.5V to 7V
$I_{IK}, I_{OK}$ (Clamp Diode Current)	$\pm 20mA$
$I_{OUT}$ (DC Output Current, per pin)	$\pm 150mA$
$I_{CC}$ (DC $V_{CC}$ or GND Current, per pin)	$\pm 150mA$
Storage Temperature Range	-65°C to + 150°C
Power Dissipation 16-pin PDIP (derate 14.3mW/°C above +70°C)	1150mW
Power Dissipation 16-pin NSOIC (derate 13.6mW/°C above +70°C)	1100mW

### CAUTION:

ESD (Electrostatic Discharge) sensitive device. Permanent damage may occur on unconnected devices subject to high energy electrostatic fields. Unused devices must be stored in conductive foam or shunts. Personnel should be properly grounded prior to handling this device. The protective foam should be discharged to the destination socket before devices are removed.

## ELECTRICAL CHARACTERISTICS

UNLESS OTHERWISE NOTED: THE FOLLOWING SPECIFICATIONS APPLY FOR  $V_{CC} = +3.0V$  TO  $+3.6V$  WITH  $T_A = +25^\circ C$  AND ALL MIN AND MAX LIMITS APPLY ACROSS THE RECOMMENDED OPERATING TEMPERATURE RANGE.

SYMBOL	PARAMETERS	MIN.	TYP.	MAX.	UNITS	CONDITIONS
$V_{CC}$	Supply Voltage	3.0		3.6	V	
$V_{IN}$ or $V_{OUT}$	DC Input or Output Voltage			$V_{CC}$	V	
<b>Input Electrical Characteristics</b>						
$t_r$ or $t_f$	Input Rise or Fall Times		3		ns	
$V_{IH}$	HIGH Level Input Voltage	2.0			V	
$V_{IL}$	LOW Level Input Voltage			0.8	V	
<b>Output Electrical Characteristics</b>						
$V_{OH}$	HIGH Level Output Voltage	2.5	2.9		V	$V_{IN} = V_{IH}$ or $V_{IL}$ , $I_{OUT} = -20mA$
$V_{OL}$	LOW Level Output Voltage		0.2	0.5	V	$V_{IN} = V_{IH}$ or $V_{IL}$ , $I_{OUT} = 20mA$
$V_T$	Differential Output Voltage	2.0	2.7		V	$R_L = 100\Omega$ , Note 1
$ V_T  -  \overline{V_T} $	Differential Output Voltage			0.4	V	$R_L = 100\Omega$ , Note 1
$V_{OS}$	Common Mode Output Voltage			3.0	V	$R_L = 100\Omega$ , Note 1
$ V_{OS} - \overline{V_{OS}} $	Difference in Common Mode Output			0.4	V	$R_L = 100\Omega$ , Note 1
$I_{CC}$	Quiescent Supply Current			100	$\mu A$	$V_{IN} = V_{CC}$ or GND, Note 2



UNLESS OTHERWISE NOTED: THE FOLLOWING SPECIFICATIONS APPLY FOR  $V_{CC} = +3.0V$  TO  $+3.6V$  WITH  $T_A = +25^{\circ}C$  AND ALL MIN AND MAX LIMITS APPLY ACROSS THE RECOMMENDED OPERATING TEMPERATURE RANGE.

SYMBOL	PARAMETERS	MIN.	TYP.	MAX.	UNITS	CONDITIONS
$I_{OZ}$	Tri-state Output Leakage Current		$\pm 2.0$		$\mu A$	$V_{OUT} = V_{CC}$ or GND, $ENABLE = V_{IL}$ , $\overline{ENABLE} = V_{IH}$
$I_{SC}$	Output Short Circuit Current	-30		-150	mA	$V_{IN} = V_{CC}$ or GND, Notes 1 & 3
$I_{OFF}$	Output Leakage Current Power Off			100	$\mu A$	$V_{CC} = 0V$ , $V_{OUT} = 6V$ , Note 1
$I_{OFF}$	Output Leakage Current Power Off			-100	$\mu A$	$V_{CC} = 0V$ , $V_{OUT} = -0.25V$ , Note 1
<b>Switching Characteristics</b>						
$t_{PLHD}$ , $t_{PHLD}$	Propagation Delays		11	18	ns	Figure 5
$t_{SKEW}$	Skew, SP26LV431C <sub>-</sub>		0.8	2	ns	Figure 5, Note 4,
$t_{SKEW}$	Skew, SP26LV431E <sub>-</sub>			3	ns	Figure 5, Note 4
$t_{TLH}$ , $t_{THL}$	Differential Output Rise/Fall Times		4	10	ns	Figure 5
$t_{PZH}$	Output Enable Time			40	ns	Figure 7
$t_{PZL}$	Output Enable Time			40	ns	Figure 7
$t_{PHZ}$	Output Disable Time			35	ns	Figure 7, Note 5
$t_{PLZ}$	Output Disable Time			35	ns	Figure 7, Note 5
$C_{PD}$	Power Dissipation Capacitance		50		pF	Note 6
$C_{IN}$	Input Capacitance		6		pF	

**NOTE:**

1. Refer to EIA specifications for RS-422 serial protocol for exact test conditions.
2. Measured per input. All other inputs at  $V_{CC}$  or GND.
3. This is the current sourced when a high output is shorted to GND. Only one output at a time should be shorted.
4. Skew is defined as the difference in propagation delays between complementary outputs at the 50% input.
5. Output disable time is the delay from  $ENABLE$  or  $\overline{ENABLE}$  being switched to the output transistors turning off. The actual disable times are less than indicated due to the delay added by the RC time constant of the load.
6.  $C_{PD}$  determines the no load dynamic power consumption,  $P_D = (C_{PD}V_{CC}^2f) + (I_{CC}V_{CC})$ , and the no load dynamic power consumption,  $I_S = (C_{PD}V_{CC}f) + I_{CC}$ .

FIGURE 3. SP431 BLOCK DIAGRAM

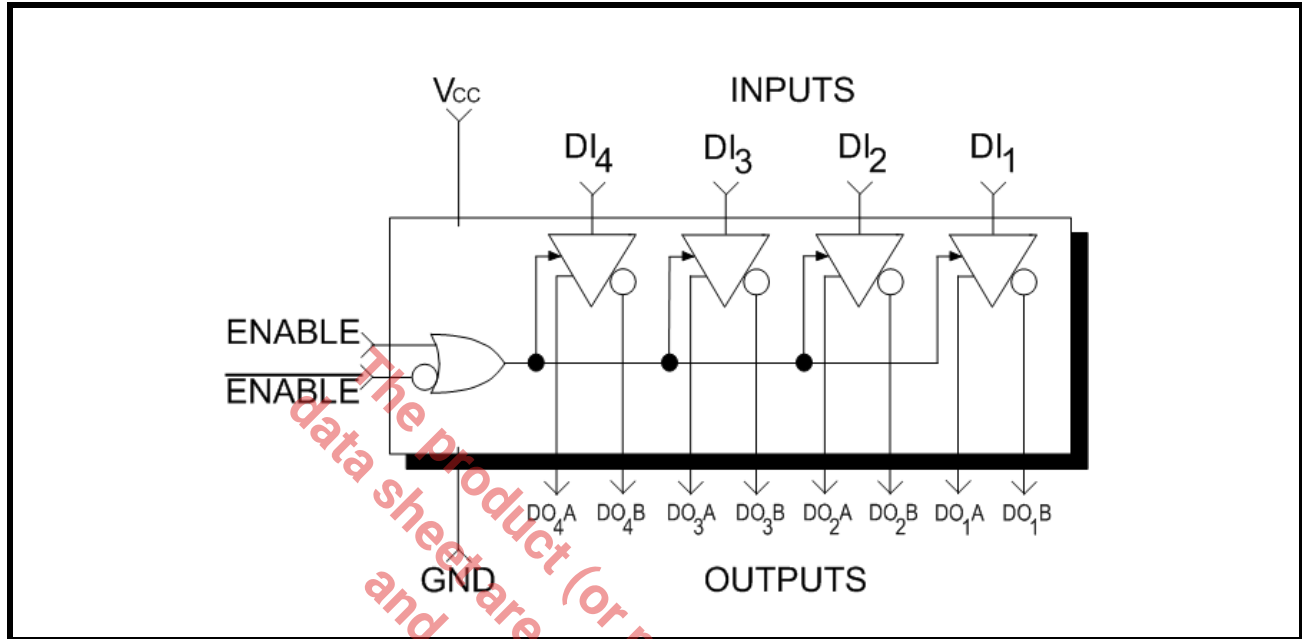

FIGURE 4. AC TEST CIRCUIT

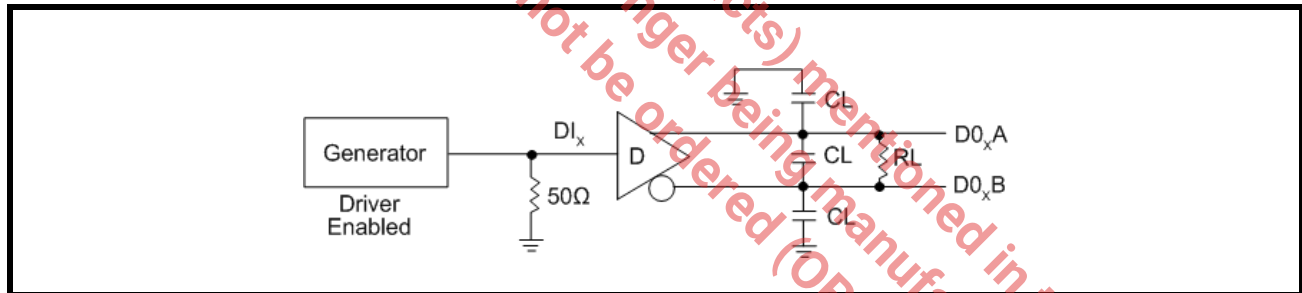

FIGURE 5. PROPAGATION DELAYS

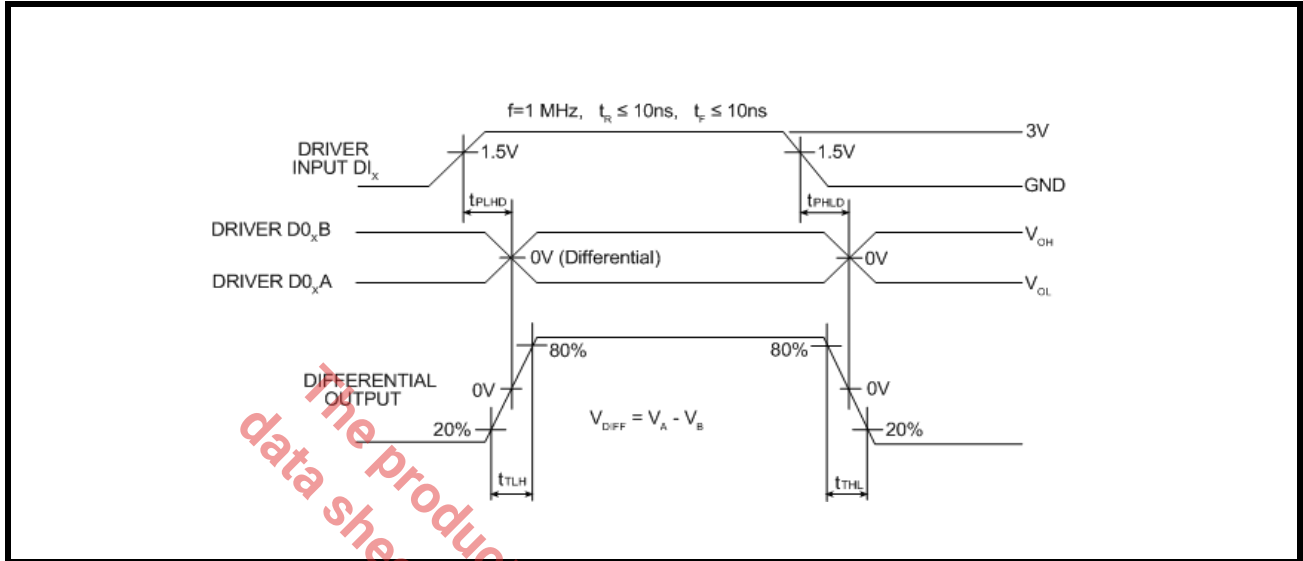

FIGURE 6. DRIVER SINGLE-ENDED TRI-STATE TEST CIRCUIT

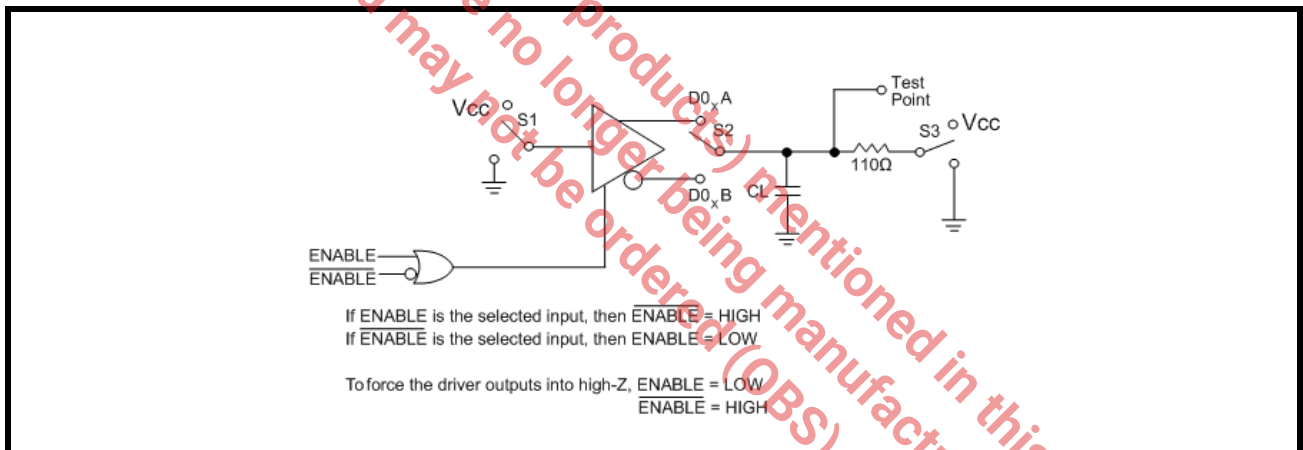

FIGURE 7. DRIVER SINGLE-ENDED TRI-STATE WAVEFORMS

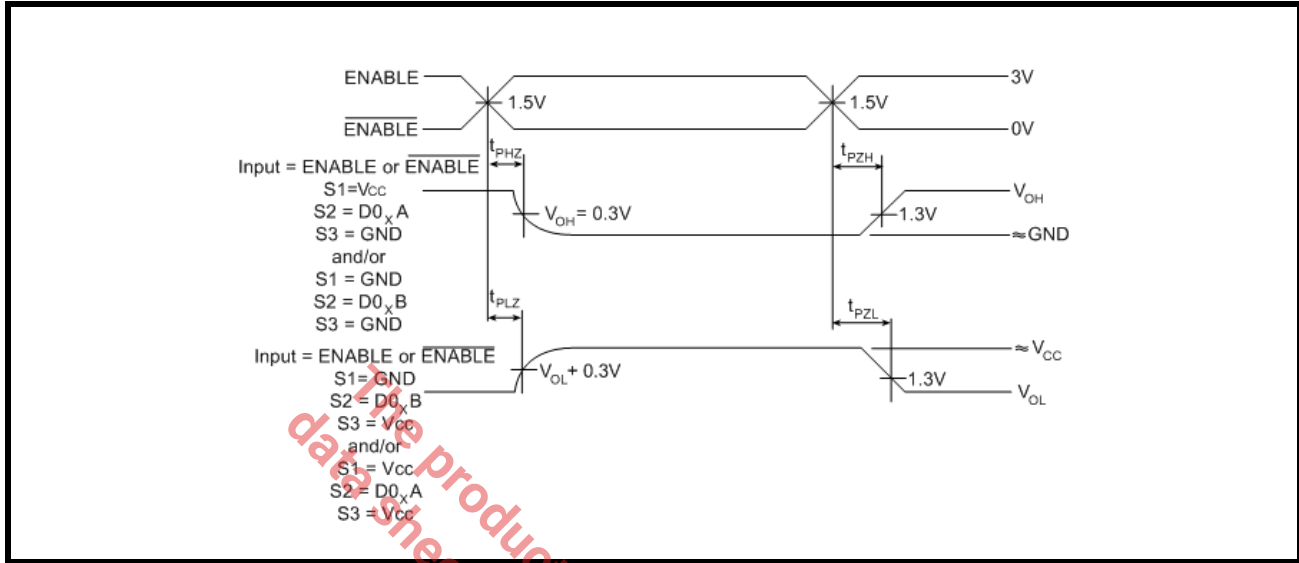
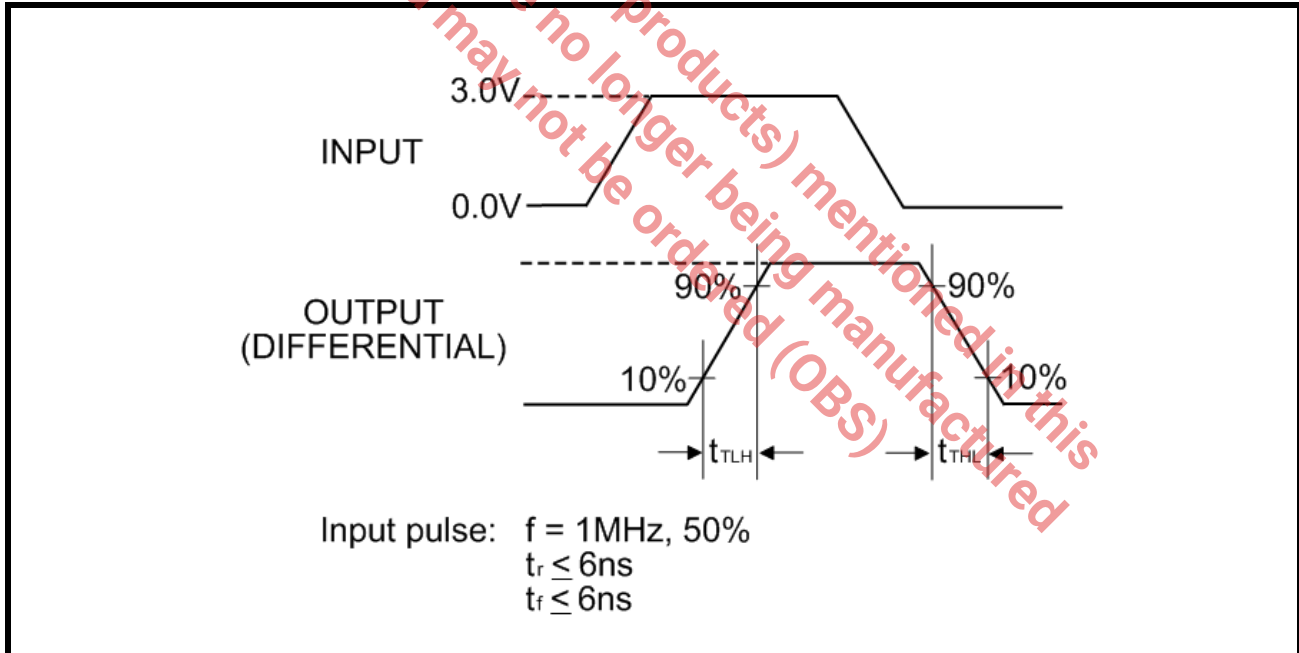

FIGURE 8. DIFFERENTIAL RISE AND FALL TIMES





**1.0 PRODUCT DESCRIPTION**

The **SP26LV431** is a low-power quad differential line driver designed for digital data transmission meeting the specifications of the EIA standard RS-422 serial protocol. The **SP26LV431** features Exar's BiCMOS process allowing low power operational characteristics of CMOS technology while meeting all of the demands of the RS-422 serial protocol up to 60Mbps under load in harsh environments.

The RS-422 standard is ideal for multi-drop applications and for long-distance communication. The RS-422 protocol allows up to 10 receivers to be connected to a data bus, making it an ideal choice for multi-drop applications. Since the cabling can be as long as 4,000 feet, RS-422 drivers are equipped with a wide common mode output range to accommodate ground potential differences. Because the RS-422 is a differential interface, data is virtually immune to noise in the transmission line.

The **SP26LV431** accepts TTL or CMOS input levels and translates these to RS-422 output levels. The **SP26LV431** features active HIGH and active LOW driver enable controls common to all four driver channels see **Table 1**. A logic HIGH on the ENABLE pin (pin 4) or a logic LOW on the  $\overline{\text{ENABLE}}$  pin (pin 12) will enable the differential driver outputs. A logic LOW on the ENABLE pin (pin 4) and a logic HIGH on the  $\overline{\text{ENABLE}}$  pin (pin 12) will force the driver outputs into high impedance (high-Z). Refer to the truth table in **Table 1**.

All drivers are internally protected against short circuits on their outputs. The driver outputs are short-circuit limited to 150mA. The driver output skew times are typically 0.8ns. To minimize reflections, the multipoint bus transmission line should be terminated at both ends in its characteristic impedance, and stub lengths off the main line should be kept as short as possible.

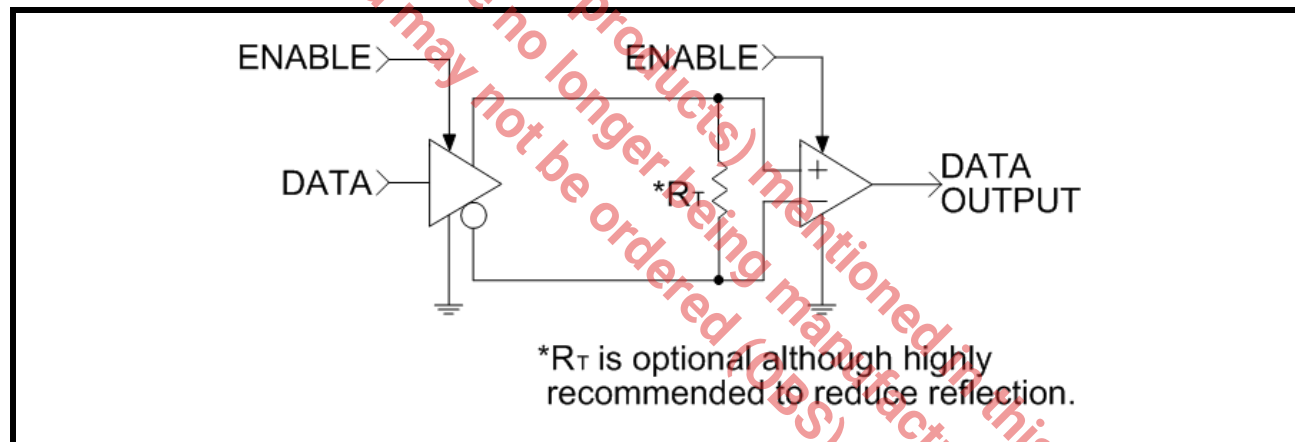
**FIGURE 9. TWO-WIRE BALANCED SYSTEM, RS-422**

**TABLE 1: TRUTH TABLE, ENABLE/DISABLE FUNCTION COMMON TO ALL FOUR RS-422 DRIVERS**

ENABLE	$\overline{\text{ENABLE}}$	INPUT	NON-INVERTING A OUTPUT	INVERTING B OUTPUT
LOW	HIGH	don't care	high-Z	high-Z
HIGH	don't care	LOW	LOW	HIGH
don't care	LOW	HIGH	HIGH	LOW

FIGURE 10. DIFFERENTIAL PROPAGATION DELAY VS TEMPERATURE

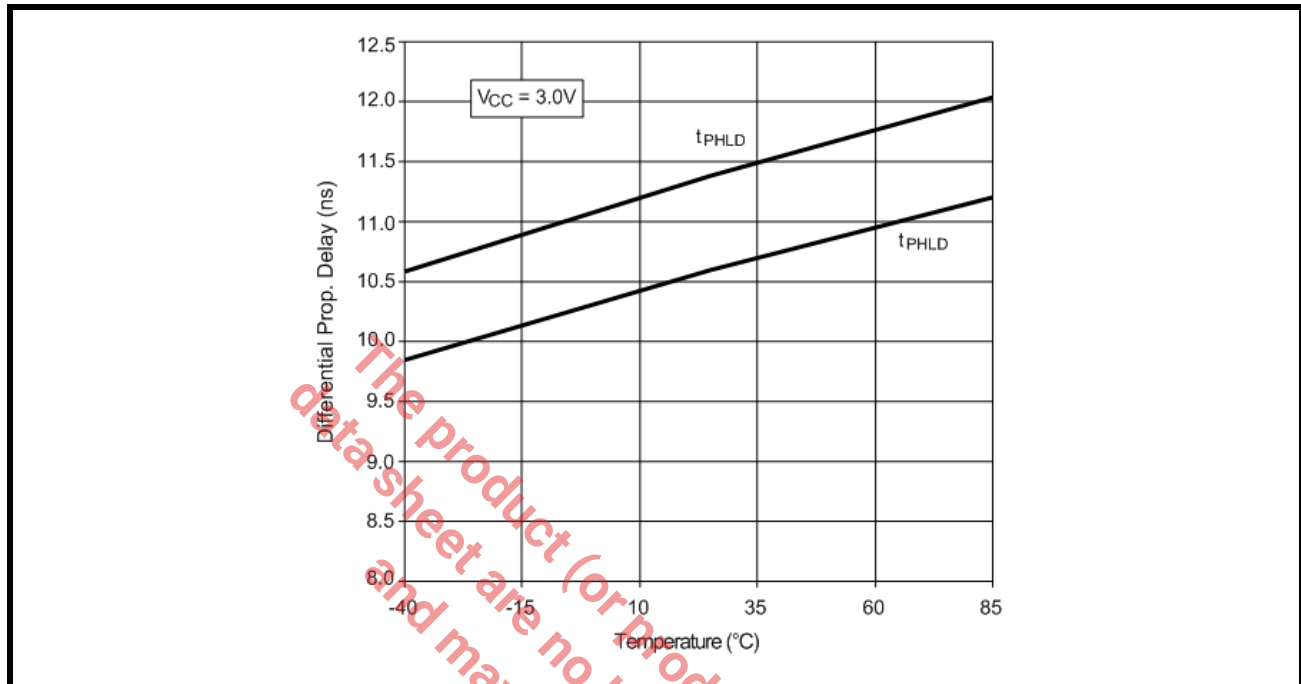

FIGURE 11. DIFFERENTIAL PROPAGATION DELAY VS VOLTAGE

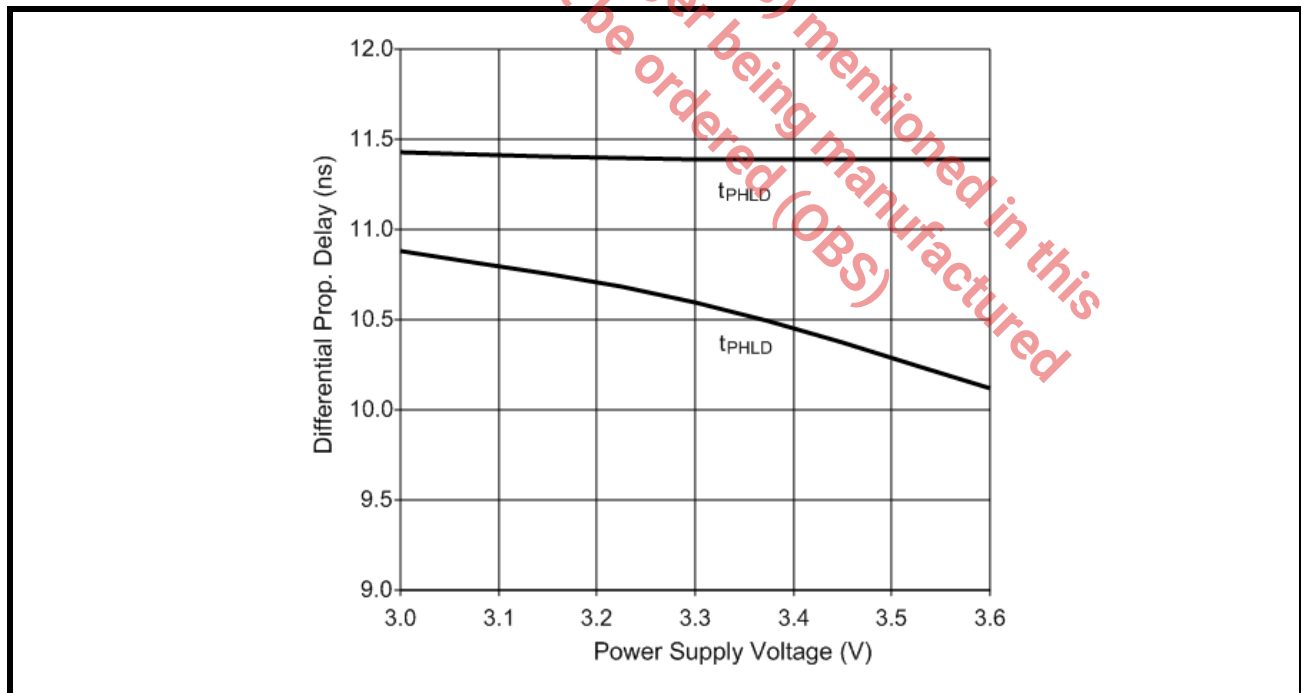

FIGURE 12. DIFFERENTIAL SKEW VS TEMPERATURE

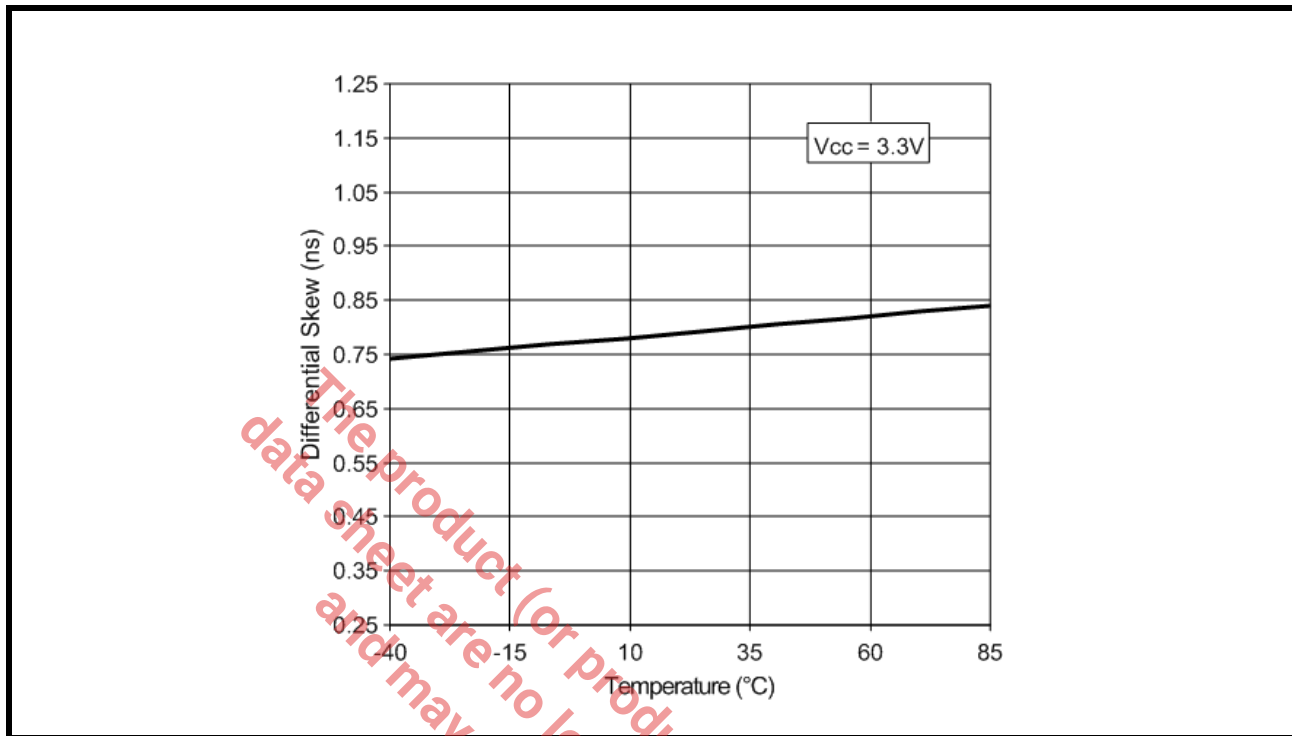

FIGURE 13. DIFFERENTIAL SKEW VS VOLTAGE

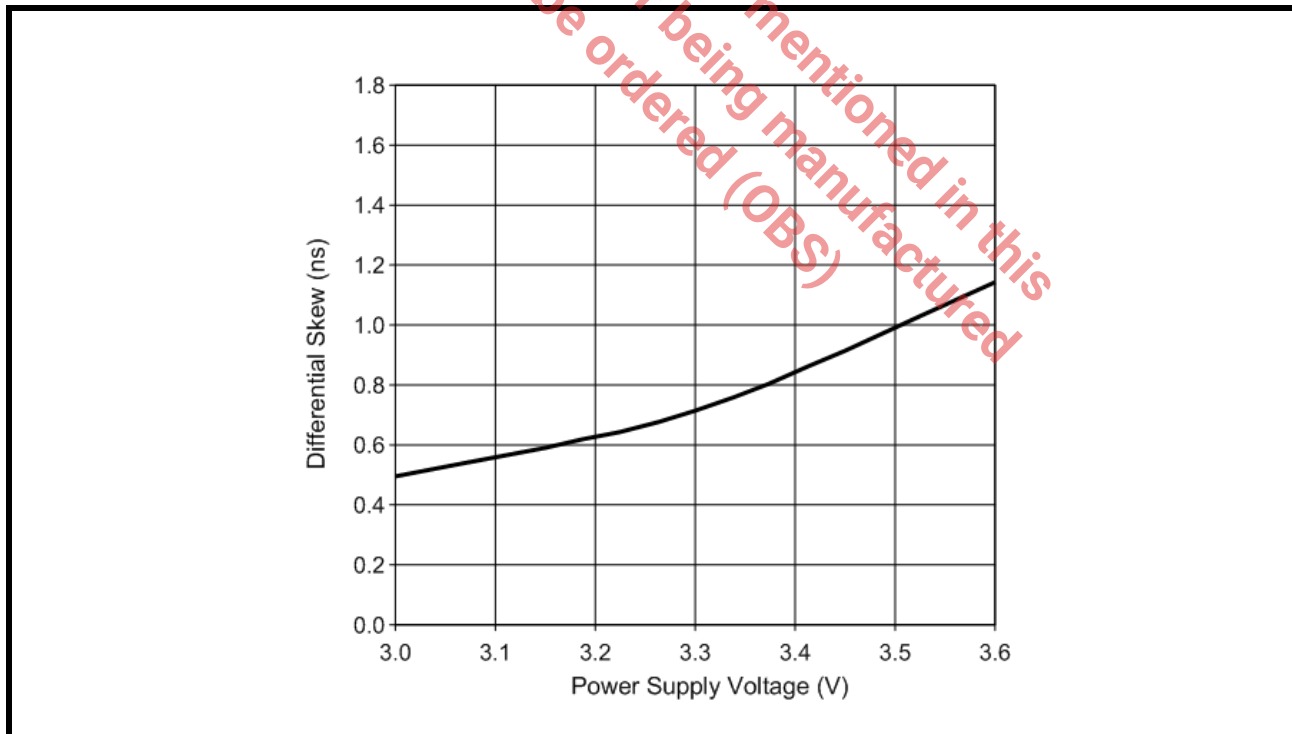

FIGURE 14. DIFFERENTIAL TRANSITION TIME VS TEMPERATURE

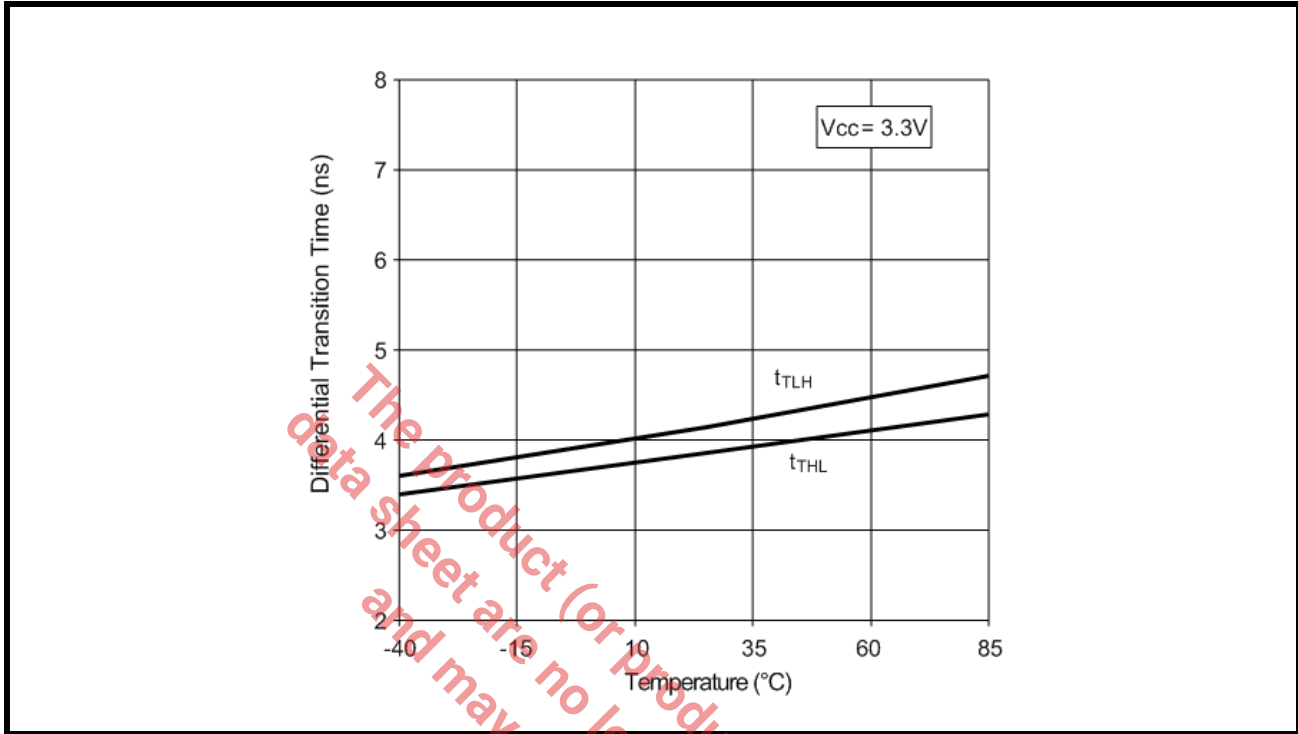

FIGURE 15. DIFFERENTIAL TRANSITION TIME VS VOLTAGE

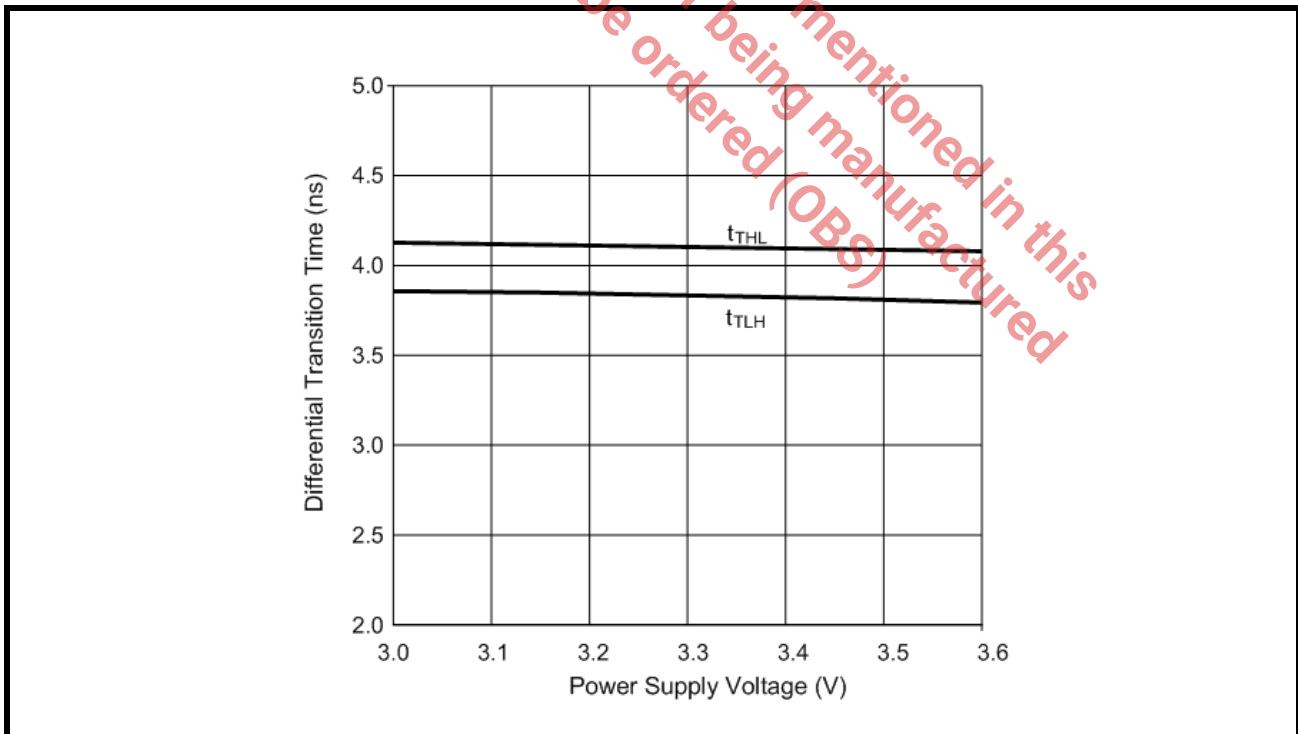

FIGURE 16. COMPLEMENTARY SKEW VS TEMPERATURE

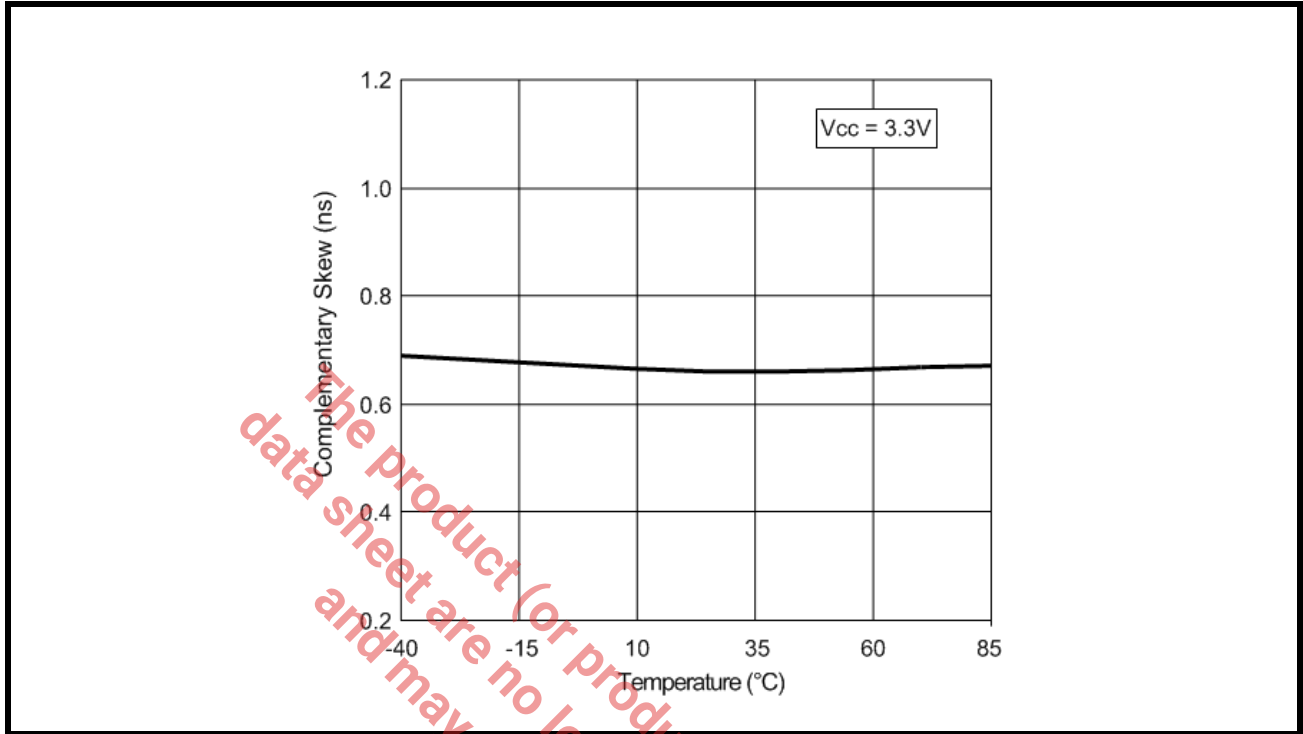

FIGURE 17. COMPLEMENTARY SKEW VS VOLTAGE

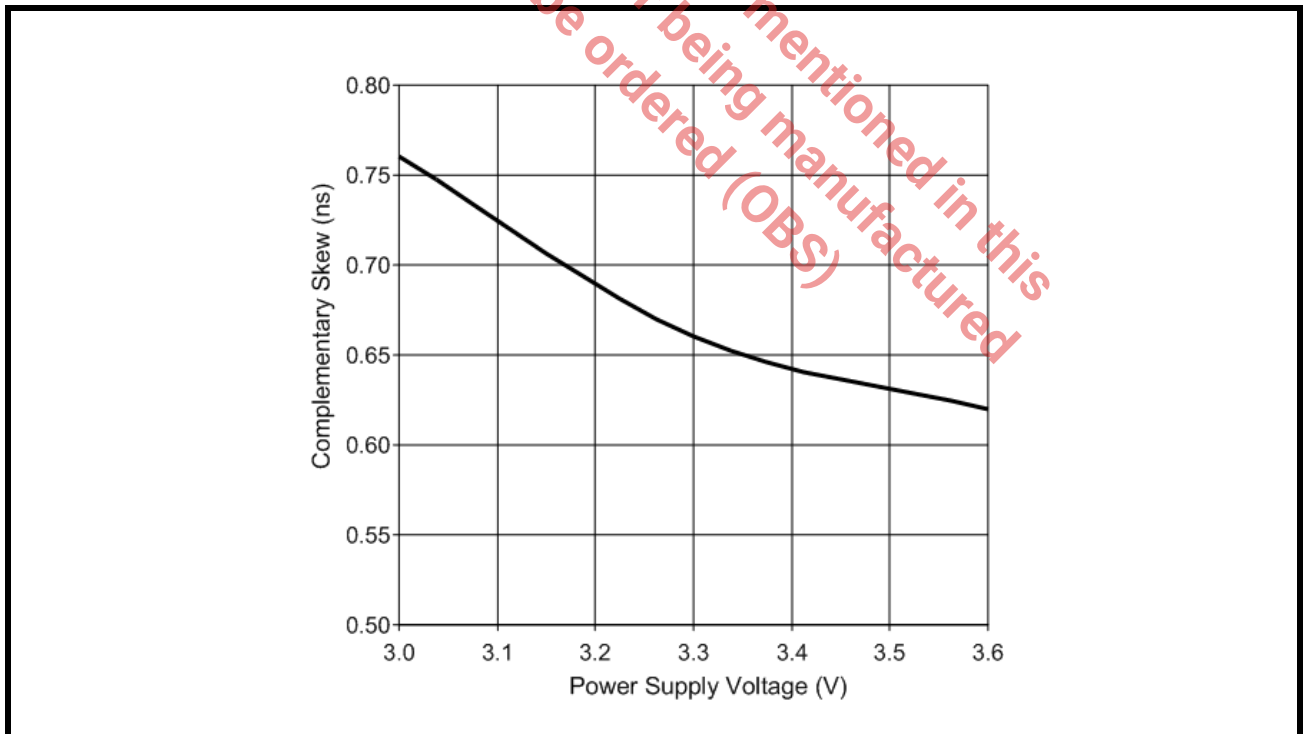

FIGURE 18. DIFFERENTIAL VOUT VS IOUT (TEMPERATURE)

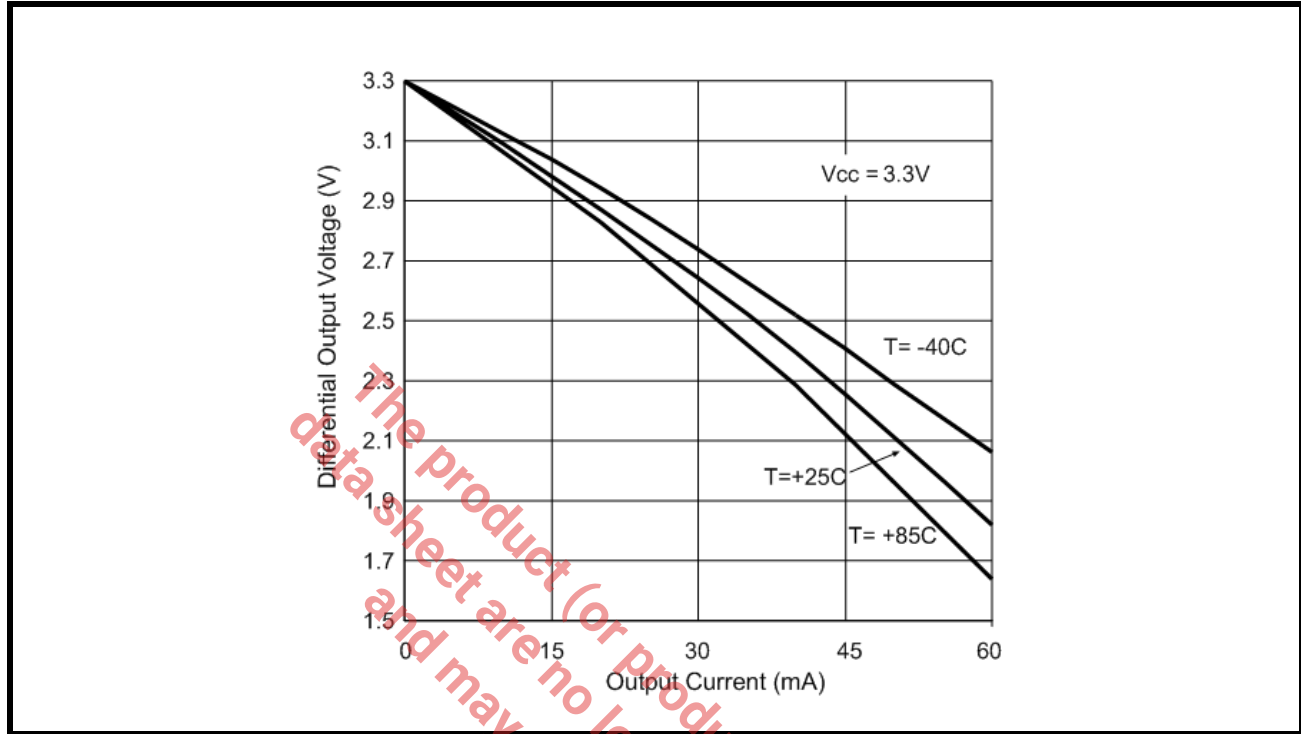

FIGURE 19. DIFFERENTIAL VOUT VS IOUT (VCC)

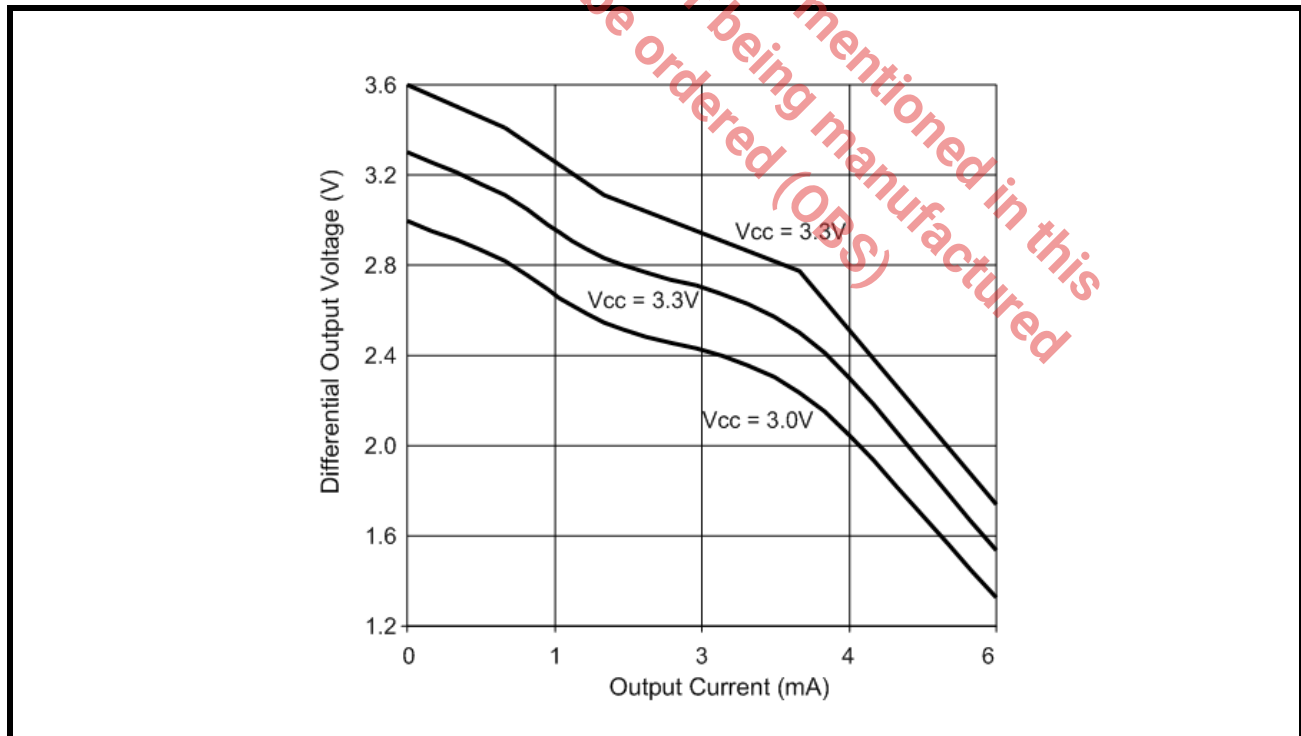

FIGURE 20. VOUT HIGH VS IOUT (TEMPERATURE)

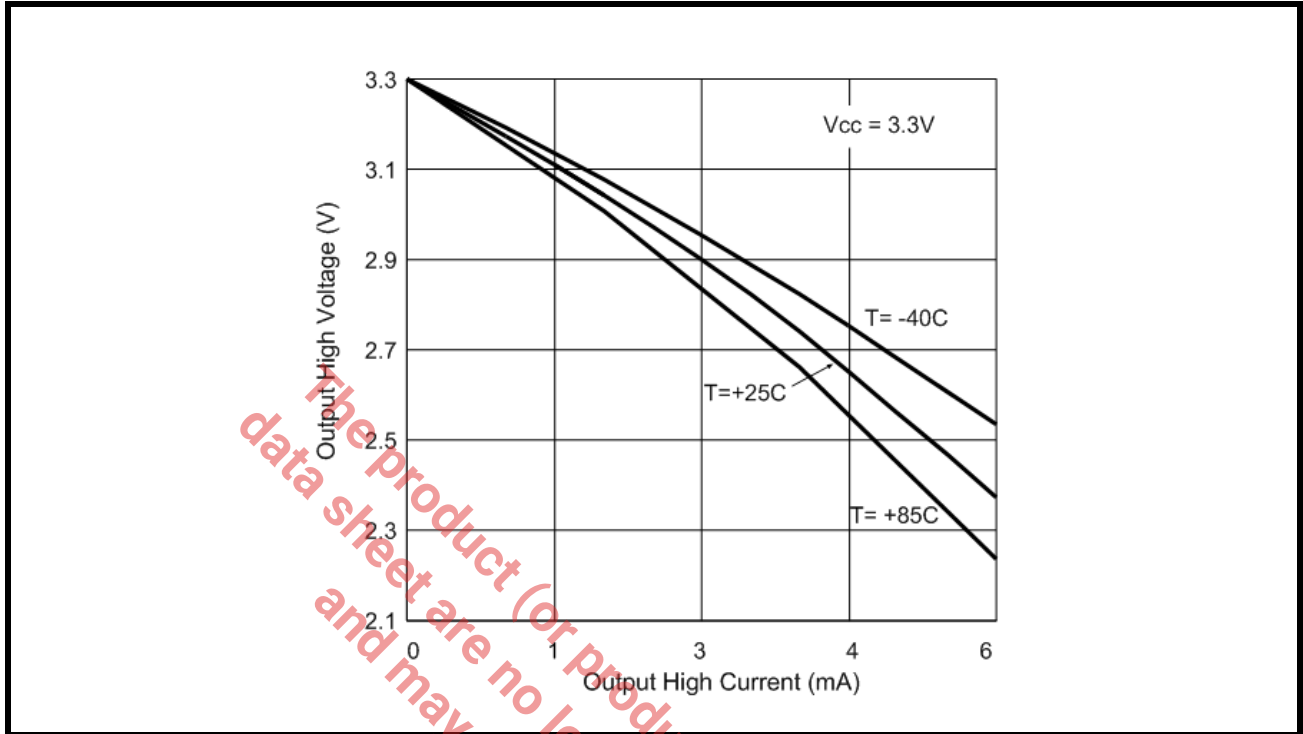

FIGURE 21. VOUT HIGH VS IOUT ( $V_{CC}$ )

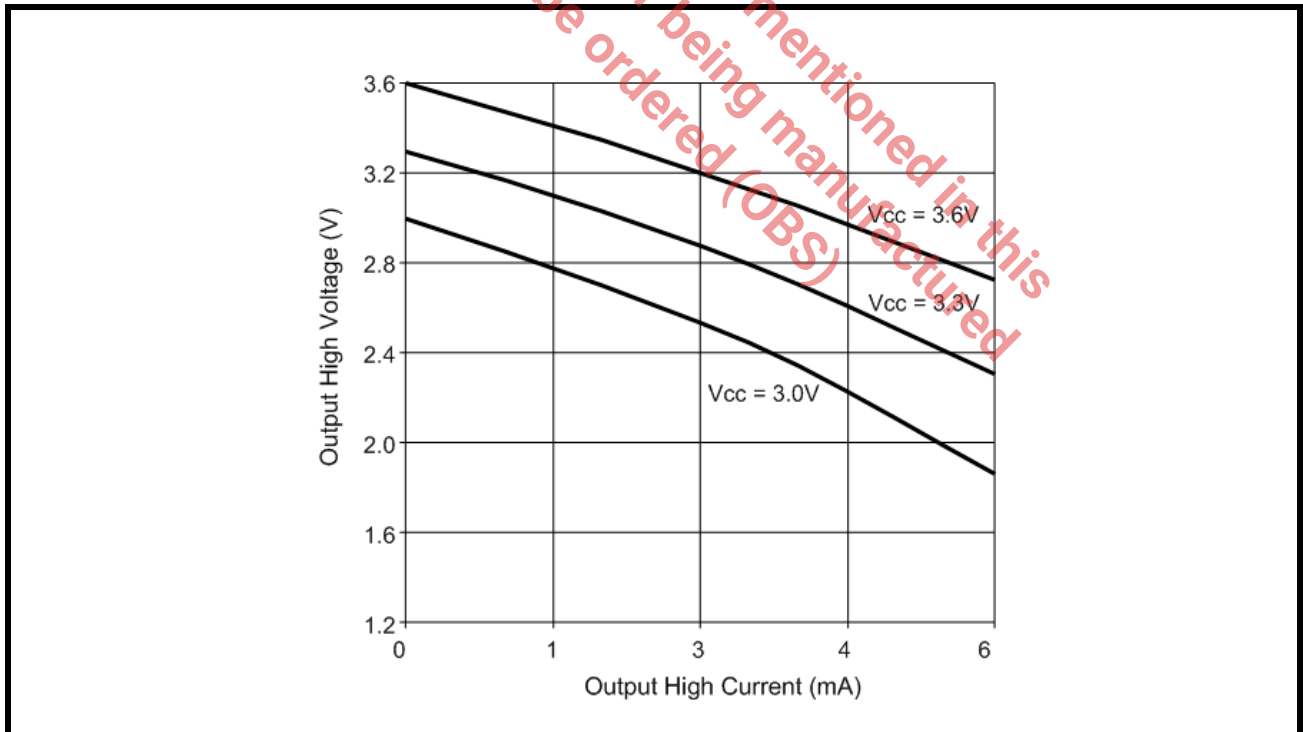

FIGURE 22. VOUT LOW VS CURRENT (TEMPERATURE)

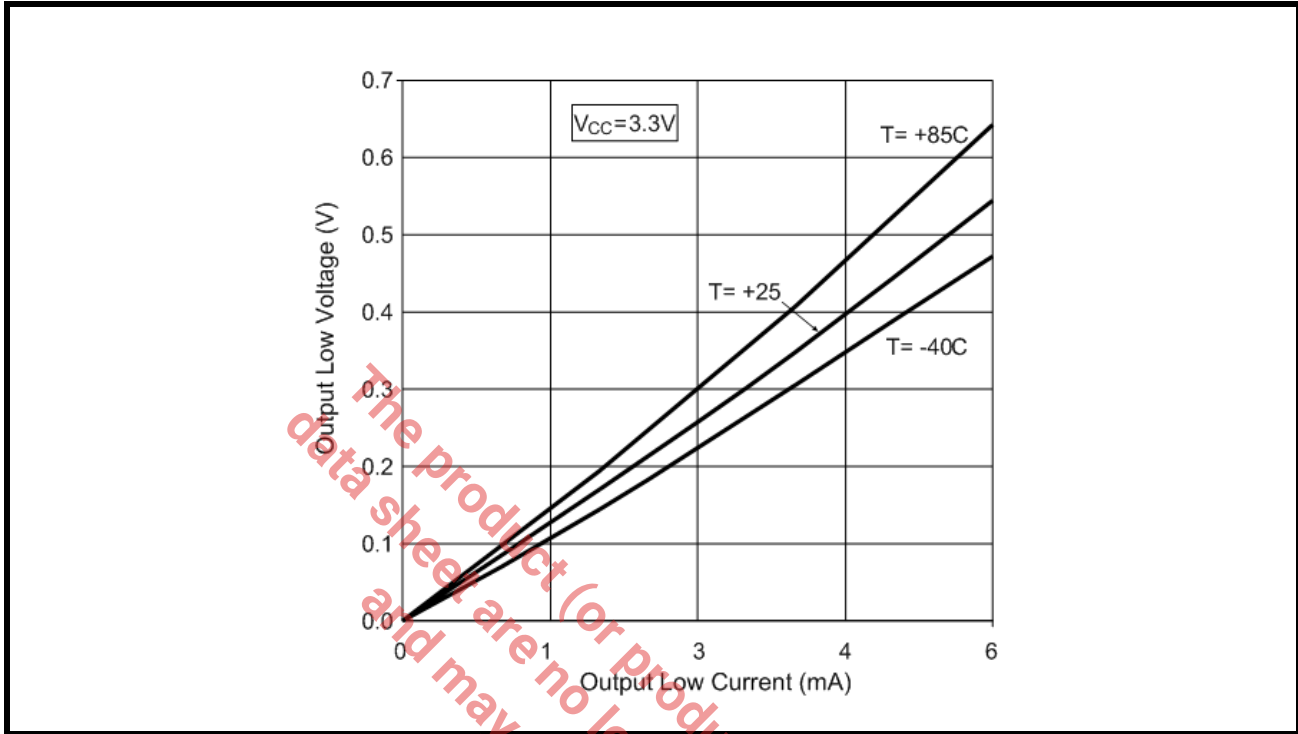

FIGURE 23. VOUT LOW VS CURRENT (VCC)

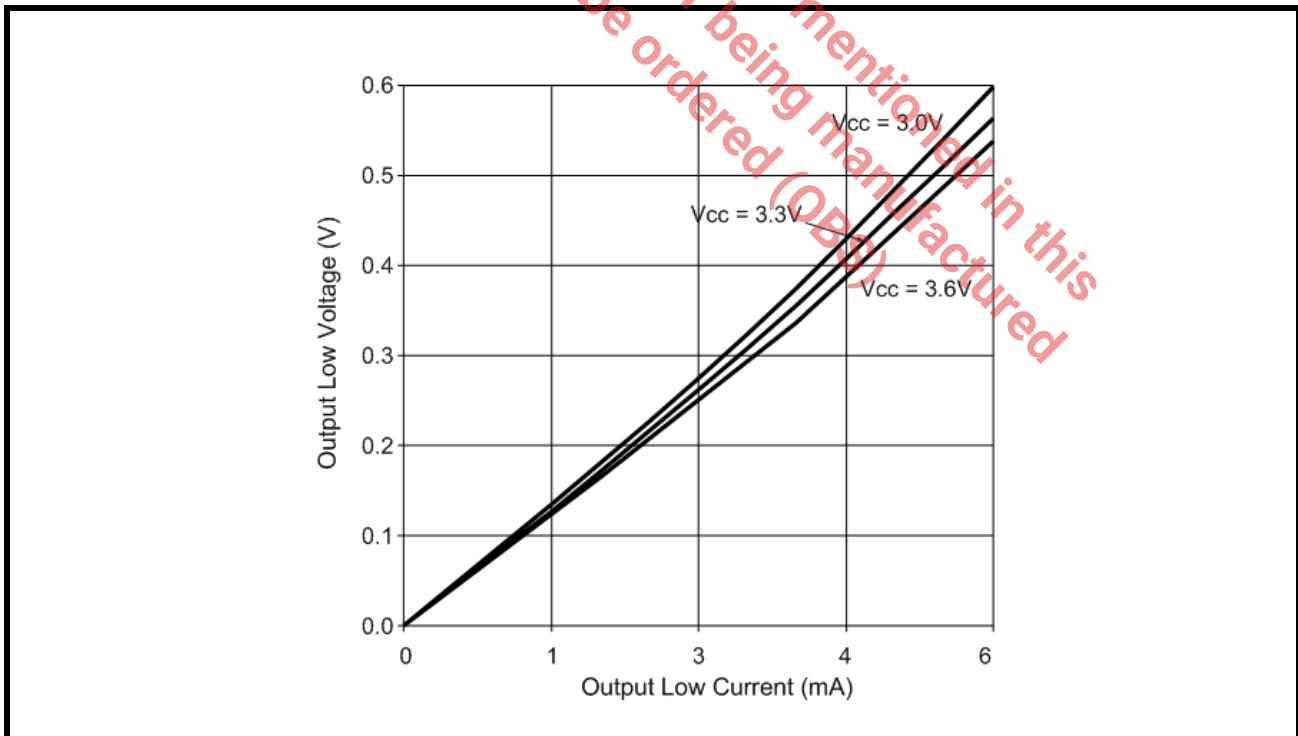



FIGURE 24. SUPPLY CURRENT VS TEMPERATURE

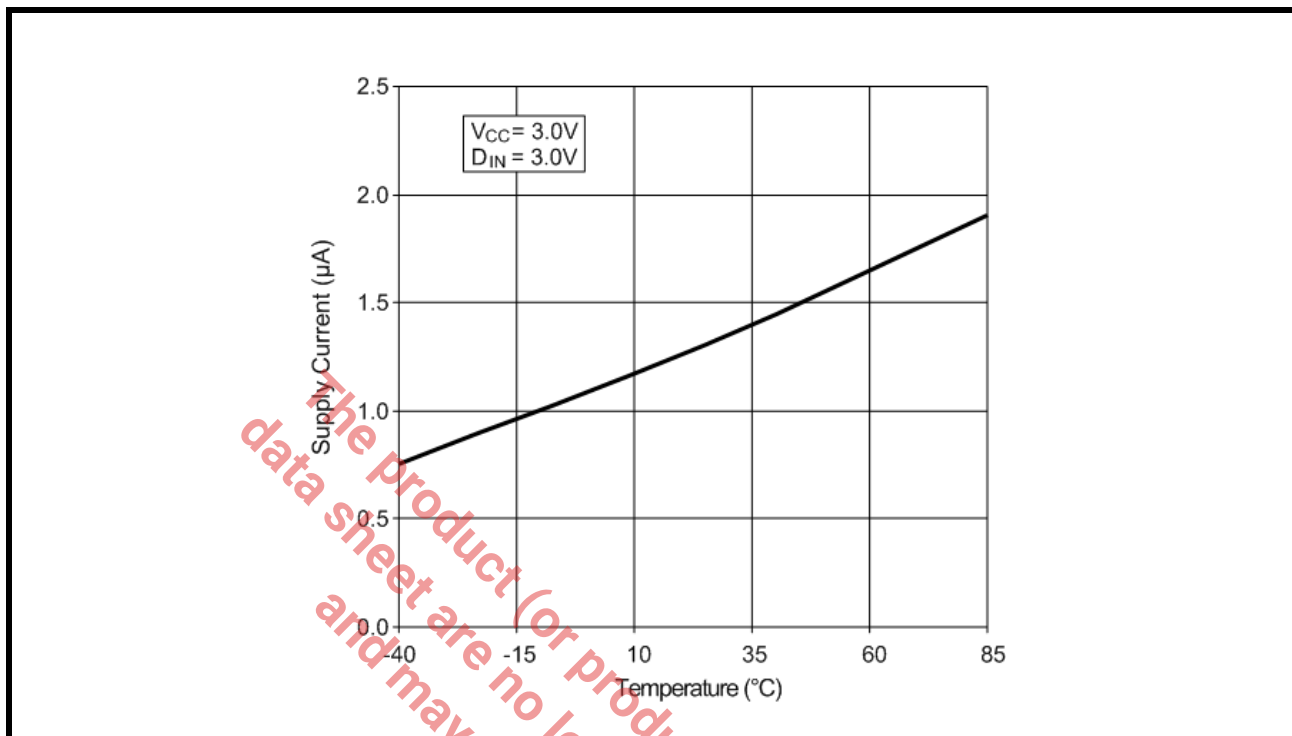

FIGURE 25. SUPPLY CURRENT VS VOLTAGE

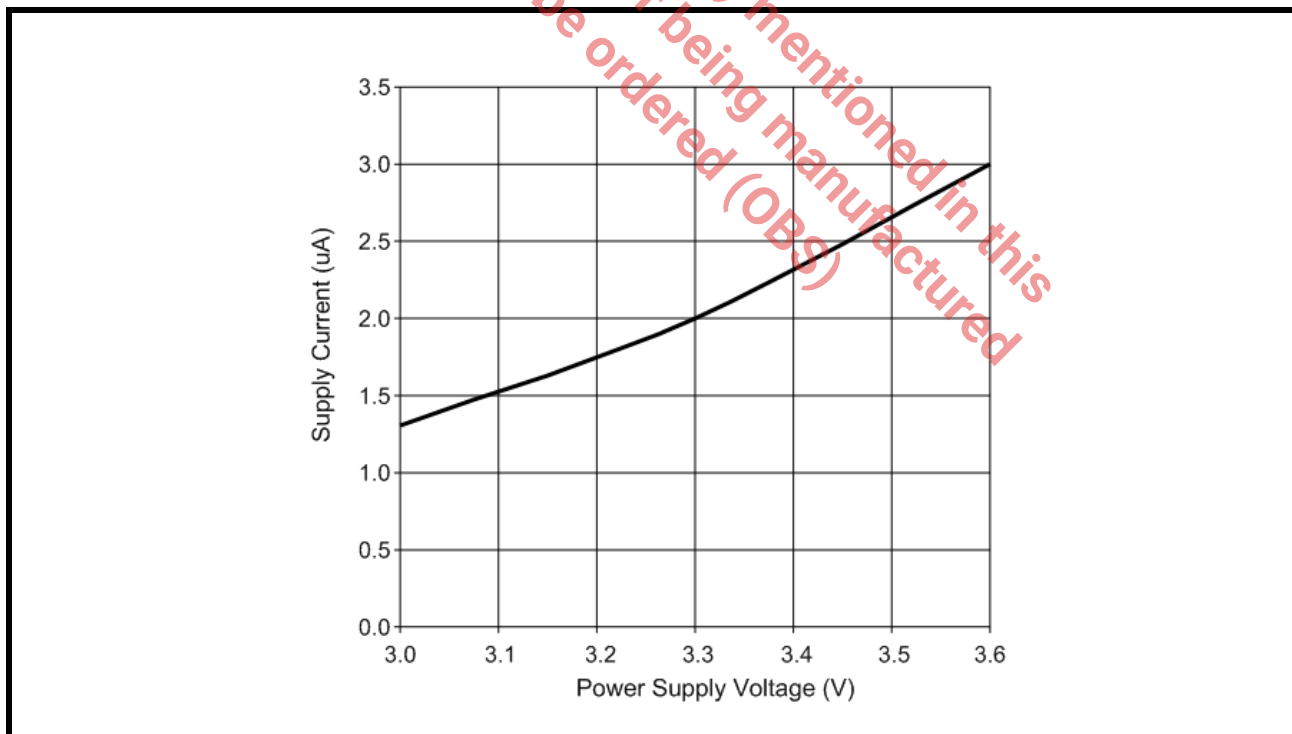

FIGURE 26. SUPPLY CURRENT VS DATA RATE

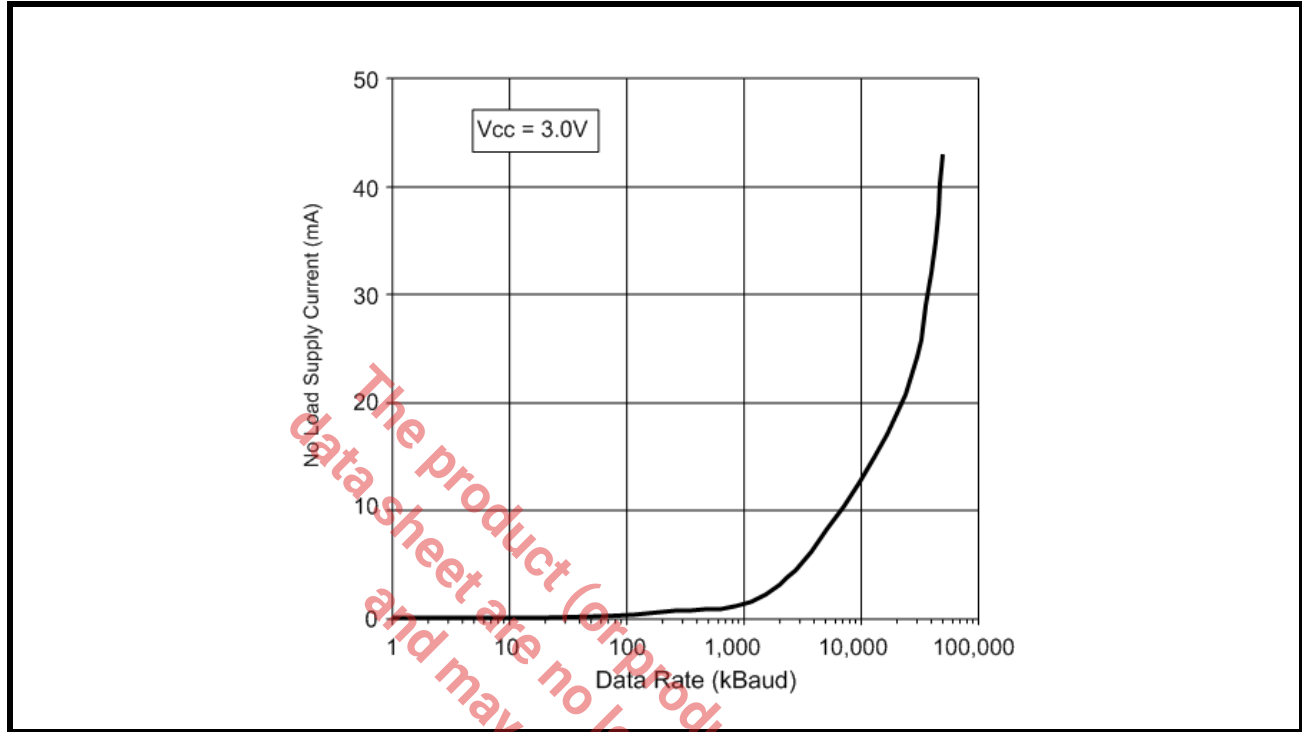

FIGURE 27. ICC (LOADED) VS DATA RATE

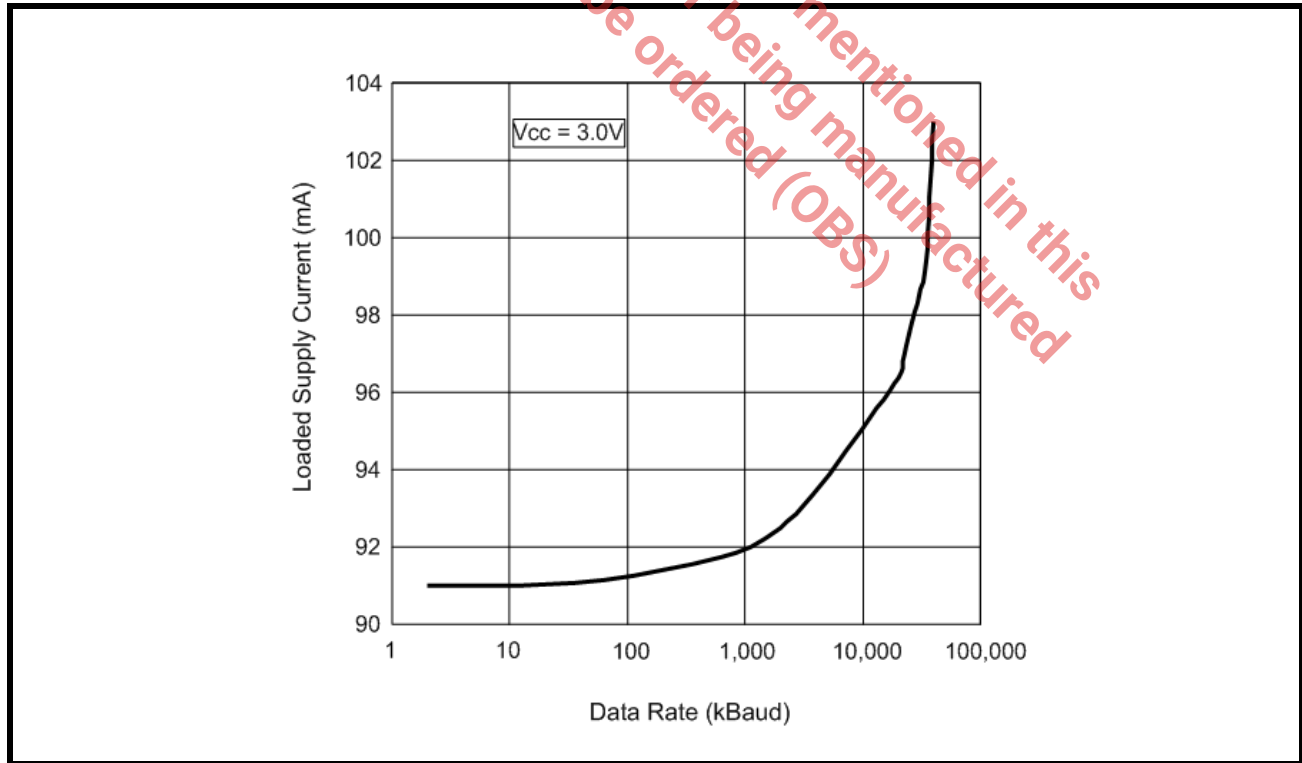

FIGURE 28. SHORT CIRCUIT CURRENT VS TEMPERATURE

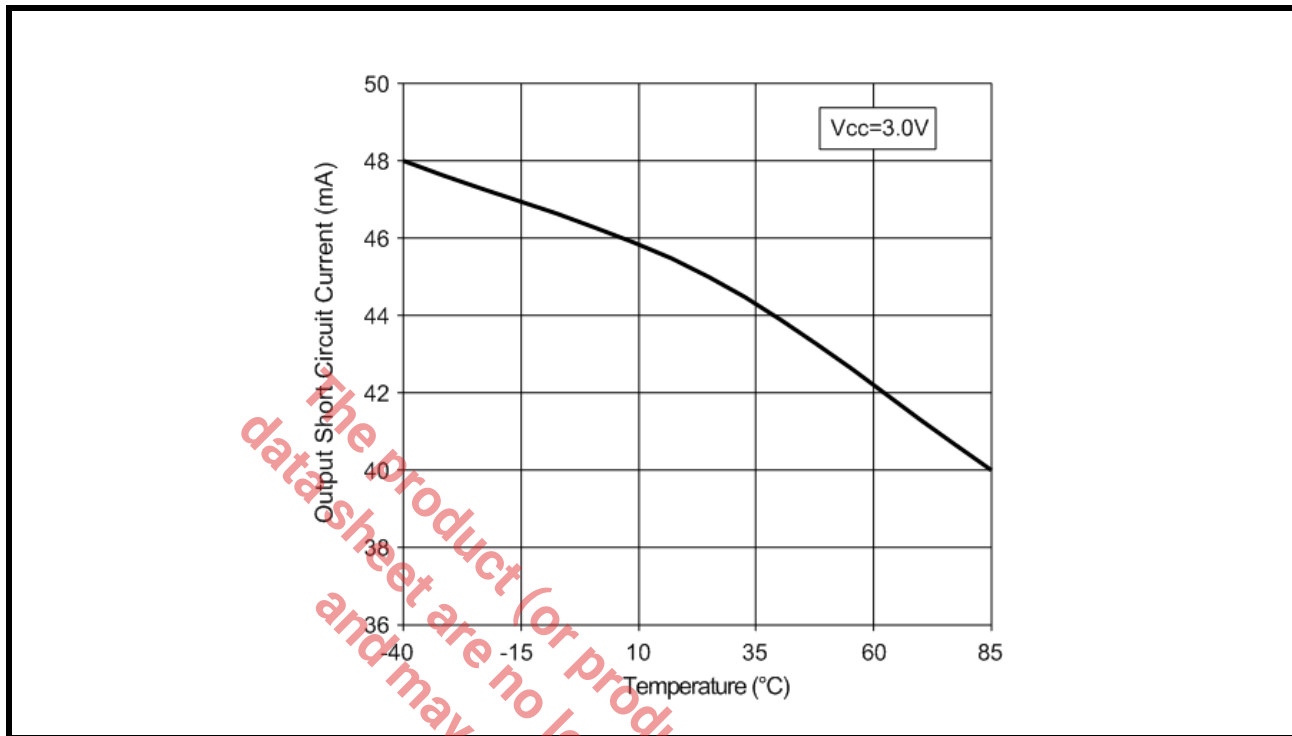
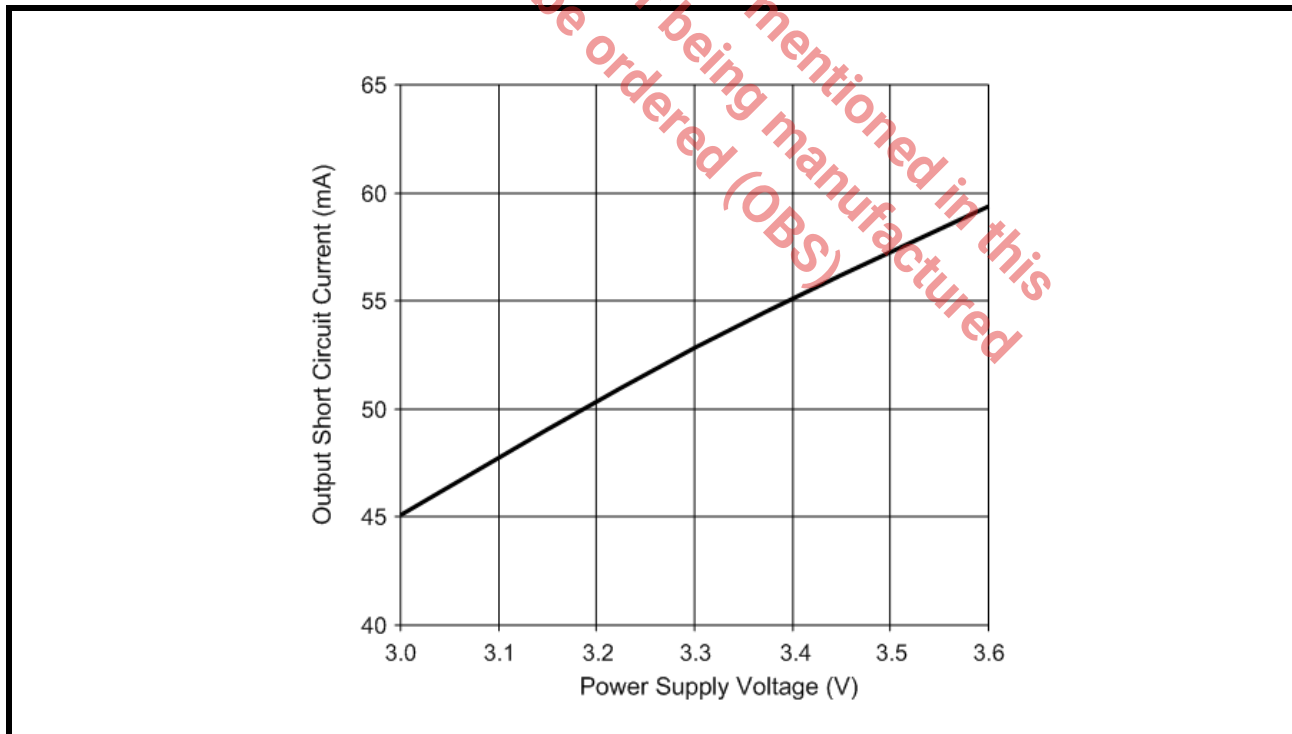
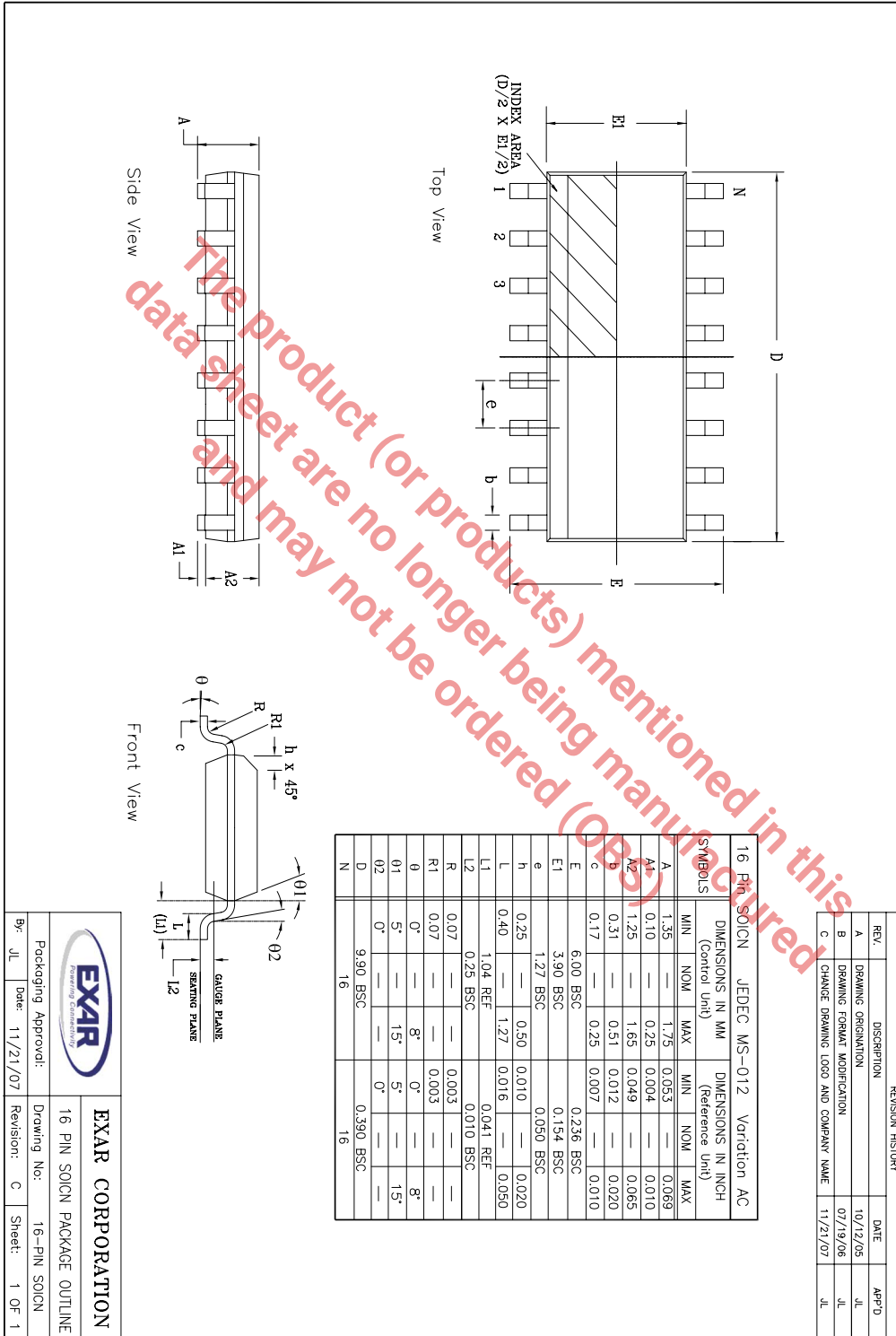

FIGURE 29. SHORT CIRCUIT CURRENT VS VOLTAGE



PACKAGE DIMENSIONS (16 PIN NSOIC)



**REVISION HISTORY**

DATE	REVISION	DESCRIPTION
3/08/04	A	Production Release.
2/24/05	B	Include tape and reel p/n's.
9/05/08	1.0.0	Converted to Exar standard datasheet format. Add -40C to +85C temperature range option. Changed revision to 1.0.0.
2/19/09	1.1.0	Add 3ns maximum driver skew for industrial temperature option.
6/03/11	1.1.1	Remove SP26LV431CP-L option per PDN 110510-01

The product (or products) mentioned in this data sheet are no longer being manufactured and may not be ordered (OBS)

**NOTICE**

EXAR Corporation reserves the right to make changes to the products contained in this publication in order to improve design, performance or reliability. EXAR Corporation assumes no responsibility for the use of any circuits described herein, conveys no license under any patent or other right, and makes no representation that the circuits are free of patent infringement. Charts and schedules contained here in are only for illustration purposes and may vary depending upon a user's specific application. While the information in this publication has been carefully checked; no responsibility, however, is assumed for inaccuracies.

EXAR Corporation does not recommend the use of any of its products in life support applications where the failure or malfunction of the product can reasonably be expected to cause failure of the life support system or to significantly affect its safety or effectiveness. Products are not authorized for use in such applications unless EXAR Corporation receives, in writing, assurances to its satisfaction that: (a) the risk of injury or damage has been minimized; (b) the user assumes all such risks; (c) potential liability of EXAR Corporation is adequately protected under the circumstances.

Copyright 2011 EXAR Corporation

Datasheet June 2011.

Send your Serial Transceiver technical inquiry with technical details to: [serialtechsupport@exar.com](mailto:serialtechsupport@exar.com).

Reproduction, in part or whole, without the prior written consent of EXAR Corporation is prohibited.