

General Description

The SP6213/14 is a 100mA CMOS linear voltage regulator offered in an SC70 package that reduces board space requirements by 50% over a SOT-23 package. The SP6213/14 features low dropout voltage (250mV at 100mA), low ground current (135 μ A at full load) and low, 65 μ A quiescent current. Designed specifically for hand-held, battery-powered devices, the device includes an enable/shutdown pin. The regulator ground current increases only slightly in dropout to extend battery life. The SP6213/14 is offered in an industry standard SC70-5 package. The SP6213/14 is available in a 3.3V fixed output voltage.

SP6213 available, SP6214 obsolete

Features

- Guaranteed 100mA output
- 2.5% output voltage accuracy
- Low dropout voltage: 250mV at 100mA
- Low quiescent current: 65 μ A
- Low ground current: 135 μ A at $I_L = 100$ mA
- Low shutdown current: 1 μ A max
- Current limit: 190mA
- Thermal shutdown: 168 $^{\circ}$ C
- Good load and line regulation
- Fast transient response: $T_{ON}/T_{OFF} = 80\mu$ s
- Low temperature coefficient
- Unconditionally stable with 1 μ F ceramic
- Fixed output: 3.3V
- 100mA replacement for 80mA MIC5213 and TC1016 (SP6213)
- 100mA replacement for 80mA NCP512 (SP6214)
- Tiny SC70-5 package

Applications

- Digital cordless phones
- Cellular phones
- PDAs
- Digital still cameras
- MP3 players
- Battery-powered equipment
- Medical devices
- Data cable

Typical Application

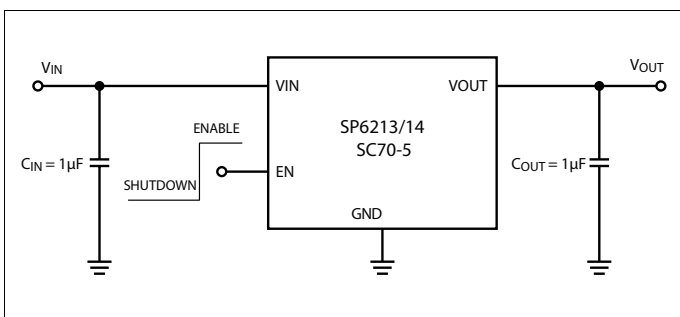

Figure 1: Typical Application

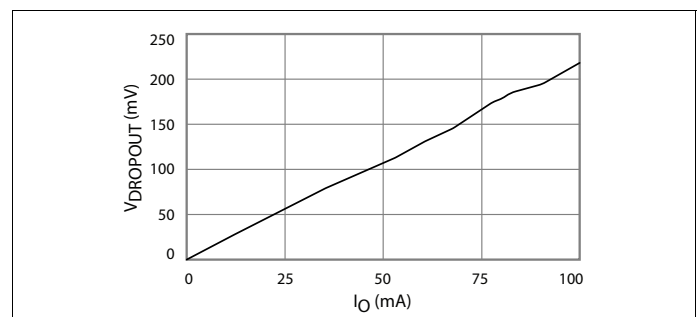

Figure 2: Dropout Voltage vs Output Current

Revision History

Revision	Release Date	Change Description
241DSR00	July 28, 2023	Updated: <ul style="list-style-type: none">■ New template applied, contents rewriting, and obsolete packages highlighted.■ Subtitle of the document.■ "General Description" section.■ "Features" section.■ "Specifications" section.■ "Mechanical Dimensions—SC70-5" figure.■ "Ordering Information" section. Added: <ul style="list-style-type: none">■ "Typical Application" section.■ "Pin Configuration" section.
--	December 13, 2005	Legacy Sipex data sheet.

Table of Contents

General Description	i
Features	i
Typical Application	i
Specifications	1
Absolute Maximum Ratings.....	1
Operating Conditions ⁽¹⁾	1
Thermal Specifications	1
Electrical Characteristics	2
Pin Information	4
Pin Configuration	4
Pin Description	4
Block Diagram	5
Application Information	6
Enable/Shutdown Operation	6
Input Capacitor	6
Output Capacitor	6
No Load Stability	6
Thermal Considerations	6
Typical Performance Characteristics	7
Mechanical Dimensions	13
SC70-5	13
Ordering Information	14

List of Figures

Figure 1: Typical Application	i
Figure 2: Dropout Voltage vs Output Current	i
Figure 3: SP6213/14 Pinout (Top View)—SC70-5 Package	4
Figure 4: Functional Block Diagram	5
Figure 5: Output Voltage vs Temperature (IO _{UT} = 0.1mA).....	7
Figure 6: Output Voltage vs Temperature (IO _{UT} = 10mA).....	7
Figure 7: Output Voltage vs Temperature (IO _{UT} = 50mA).....	7
Figure 8: Output Voltage vs Temperature (IO _{UT} = 100mA).....	7
Figure 9: Quiescent Current vs Temperature (IO _{UT} = 0A)	7
Figure 10: Dropout Voltage vs Temperature	7
Figure 11: Output Voltage vs Output Current	8
Figure 12: Output Voltage vs Input Voltage.....	8
Figure 13: Quiescent Current vs Input Voltage	8
Figure 14: Ground Current vs Output Current	8
Figure 15: Ground Current vs Input Voltage.....	8
Figure 16: Dropout Voltage vs Output Current	8
Figure 17: Power Supply Rejection Ratio (V _O = 3V).....	9
Figure 18: Turn-on Characteristic (V _{IN} = 4V, IO _{UT} = 100 μ A).....	9
Figure 19: Turn-on Characteristic (V _{IN} = 4V, IO _{UT} = 100mA).....	9
Figure 20: Turn-on Characteristic (V _{IN} = 7V, IO _{UT} = 100 μ A).....	9
Figure 21: Turn-on Time (V _{IN} = 7V, IO _{UT} = 100mA).....	9
Figure 22: Turn-off Time (V _{IN} = 4V, IO _{UT} = 100 μ A).....	9
Figure 23: Turn-off Time (V _{IN} = 4V, IO _{UT} = 100mA).....	10
Figure 24: Turn-off Time (V _{IN} = 7V, IO _{UT} = 100 μ A).....	10
Figure 25: Turn-off Time (V _{IN} = 7V, IO _{UT} = 100mA).....	10
Figure 26: Inrush Current (V _{IN} = 4V, IO _{UT} = 100 μ A)	10
Figure 27: Inrush Current (V _{IN} = 4V, IO _{UT} = 100mA)	10
Figure 28: Load Transient Response (V _{IN} = 4V)	10
Figure 29: Load Transient Response (V _{IN} = 4V)	11
Figure 30: Load Transient Response (V _{IN} = 7V)	11
Figure 31: Load Transient Response (V _{IN} = 7V)	11
Figure 32: Line Transient Response (V _{IN} = 4V, IO _{UT} = 100 μ A)	11
Figure 33: Line Transient Response (V _{IN} = 4V, IO _{UT} = 10mA)	11
Figure 34: Line Transient Response (V _{IN} = 7V, IO _{UT} = 100 μ A)	11
Figure 35: Line Transient Response (V _{IN} = 7V, IO _{UT} = 10 μ A)	12
Figure 36: Mechanical Dimensions—SC70-5.....	13

List of Tables

Table 1: Absolute Maximum Ratings	1
Table 2: Operating Conditions	1
Table 3: Thermal Performance	1
Table 4: Electrical Characteristics	2
Table 5: Pin Description.....	4
Table 6: Ordering Information.....	14

Specifications

SP6213 available, SP6214 obsolete

Absolute Maximum Ratings

Important: The stresses above what is listed under the following table may cause permanent damage to the device. This is a stress rating only—functional operation of the device above what is listed under the following table or any other conditions beyond what MaxLinear recommends is not implied. Exposure to conditions above the recommended extended periods of time may affect device reliability. Solder reflow profile is specified in the *IPC/JEDEC J-STD-020C* standard. Devices are electrostatic discharge (ESD) sensitive. Handling precautions are recommended.

Table 1: Absolute Maximum Ratings

Parameter	Min	Max	Units
Supply Input Voltage	-2	7	V
Ouput Voltage	-0.6	(V _{IN} + 1V)	V
Enable Input Voltage	-2	7	V
Power Dissipation	Internally Limited ⁽¹⁾		-
Lead Temperature (soldering 5s)	-	260	°C
Storage Temperature	-65	150	°C

1. The maximum allowable power dissipation at any T_A (ambient temperature) is P_{D(MAX)} = (T_{J(MAX)} - T_A)/θ_{JA}. Exceeding the maximum allowable power dissipation results in excessive die temperature and the regulator goes into thermal shutdown. The θ_{JA} of the SP6213/14 (SC70-5) is 330°C/W mounted on a PC board with minimum copper area (for more information, see [“Thermal Considerations”](#) on page 6).

Operating Conditions ⁽¹⁾

Table 2: Operating Conditions

Parameter	Min	Max	Units
Input Voltage	2.5	6	V
Enable Input Voltage	0	6	V
Junction Temperature	-40	125	°C

1. The maximum allowable power dissipation at any T_A (ambient temperature) is P_{D(MAX)} = (T_{J(MAX)} - T_A)/θ_{JA}. Exceeding the maximum allowable power dissipation results in excessive die temperature and the regulator goes into thermal shutdown. The θ_{JA} of the SP6213/14 (SC70-5) is 330°C/W mounted on a PC board with minimum copper area (for more information, see [“Thermal Considerations”](#) on page 6).

Thermal Specifications

Table 3: Thermal Performance

Symbol	Parameter	Package	Typ	Units
θ _{JA}	Junction to Ambient	SC70-5	330	°C/W

Electrical Characteristics

Electrical characteristics at $V_{IN} = V_{OUT} + 0.5V$, $I_L = 100\mu A$, $C_{IN} = 1\mu F$, $C_{OUT} = 1\mu F$, $T_J = 25^\circ C$, unless otherwise specified. The • denotes the specifications that apply over the full temperature range of $-40^\circ C$ to $125^\circ C$, unless otherwise specified.

Table 4: Electrical Characteristics

Parameter	Conditions		Min	Typ	Max	Units
Output Voltage Accuracy	Variation from specified V_{OUT}		-2.5	-	2.5	%
		•	-4	-	4	%
Output Voltage Temperature Coefficient ($\Delta V_{OUT}/\Delta T$) ⁽¹⁾	-		-	60	-	ppm/ $^\circ C$
Minimum Supply Voltage	$I_{OUT} = 100\mu A$		-	2.50	2.70	V
	$I_{OUT} = 50mA$		-	2.55	2.85	V
	$I_{OUT} = 100mA$		-	2.75	3.00	V
Line Regulation ($\Delta V_{OUT}/V_{IN}$)	$V_{IN} = (V_{OUT} + 0.5V)$ to 6V	•	-	0.05	0.2	%/V
SP6213 – 1.8V Line Regulation	$V_{IN} = 2.8V$ to 6V	•	-	0.05	0.2	%/V
Load Regulation ⁽²⁾	$I_L = 0.1mA$ to 100mA, $V_{IN} = V_{OUT} + 1V$	•	-	0.4	0.8	%
SP6213 – 1.8V Load Regulation	$I_L = 0.1mA$ to 100mA, $V_{IN} = 3.0V$	•	-	0.4	0.8	%
Dropout Voltage ($V_{IN} - V_{OUT}$) ⁽³⁾	$I_L = 100\mu A$	•	-	0.25	4	mV
	$I_L = 50mA$	•	-	130	250	mV
	$I_L = 100mA$	•	-	250	500	mV
Quiescent Current	$V_{EN} \leq 0.4V$ (shutdown)	•	-	0.01	1	μA
	$V_{EN} \geq 1.6V$ (operating), $I_L = 0\mu A$	•	-	65	125	μA
Ground Pin Current ⁽⁴⁾	$V_{EN} \geq 1.6V$, $I_L = 100\mu A$	•	-	65	125	μA
	$V_{EN} \geq 1.6V$, $I_L = 50mA$	•	-	100	175	μA
	$V_{EN} \geq 1.6V$, $I_L = 100mA$	•	-	135	250	μA
Power Supply Rejection Ratio (PSRR)	Frequency = 100Hz, $I_L = 10mA$		-	74	-	dB
	Frequency = 400Hz, $I_L = 10mA$		-	40	-	dB
Current Limit	-	•	120	190	350	mA
Thermal Limit	Turns on		-	168	-	$^\circ C$
	Turns off		-	153	-	$^\circ C$
Thermal Regulation ($\Delta V_{OUT}/\Delta P_D$) ⁽⁵⁾	-		-	0.05	-	%/W
Output Noise	$I_L = 50mA$, $C_L = 1\mu F$, 10Hz to 100kHz		-	250	-	μV_{RMS}

Table 4: Electrical Characteristics (Continued)

Parameter	Conditions		Min	Typ	Max	Units
Enable Input						
Enable Input Logic-Low Voltage	Regulator shutdown	•	-	-	0.4	V
Enable Input Logic-High Voltage	Regulator enabled	•	1.6	-	-	V
Enable Input Current	$V_{IL} \leq 0.4V$	•	-	0.01	1	μA
	$V_{IH} \geq 1.6V$	•	-	0.01	1	μA
Turn-on Time	$I_{OUT} = 50mA$		-	80	165	μS
Turn-off Time	$I_{OUT} = 100\mu A$		-	80	175	μS
	$I_{OUT} = 100mA$		-	30	35	μS

1. Output voltage temperature coefficient is defined as the worst-case voltage change divided by the total temperature range.
2. Load regulation is measured at constant junction temperature using low duty cycle pulse testing. Parts are tested for load regulation in the load range. Changes in output voltage due to heating effects are covered by the thermal regulation specification.
3. Dropout voltage is defined as the input-to-output differential at which the output voltage drops 2% below its nominal value measured at 0.5V differential. Not applicable to output voltages less than 2.7V.
4. Ground pin current is the regulator quiescent current. The total current drawn from the supply is the sum of the load current plus the ground pin current.
5. Thermal regulation is defined as the change in output voltage at a time t after a change in power dissipation is applied, excluding load or line regulation effects. Specifications are for a 100mA load pulse at $V_{IN} = 6V$ for $t = 10ms$.

Pin Information

SP6213 available, SP6214 obsolete

Pin Configuration

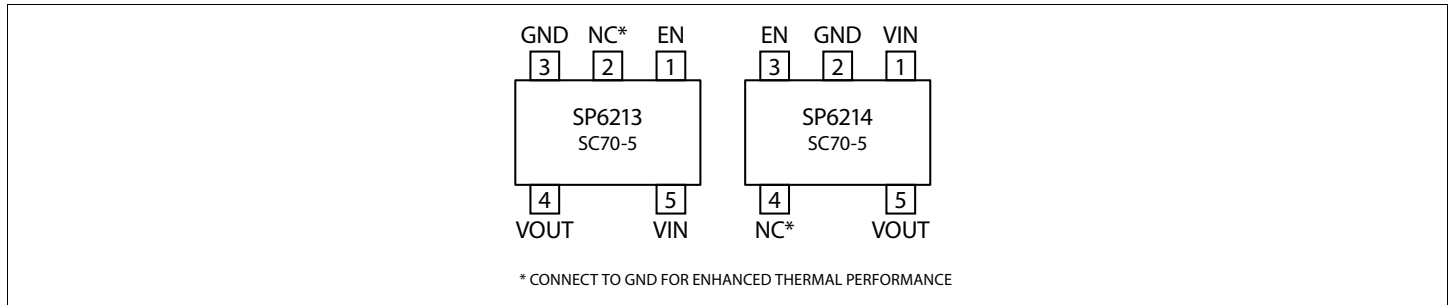

Figure 3: SP6213/14 Pinout (Top View)—SC70-5 Package

Pin Description

Table 5: Pin Description

Pin Number	Pin Name	Description
SP6213		
1	EN	Enable/shutdown (logic high = enable, logic low = shutdown).
2	NC	No connection.
3	GND	Ground connection.
4	VOUT	Regulator output.
5	VIN	Supply input.
SP6214		
1	VIN	Supply input.
2	GND	Ground connection.
3	EN	Enable/shutdown (logic high = enable, logic low = shutdown).
4	NC	No connection.
5	VOUT	Regulator output.

Block Diagram

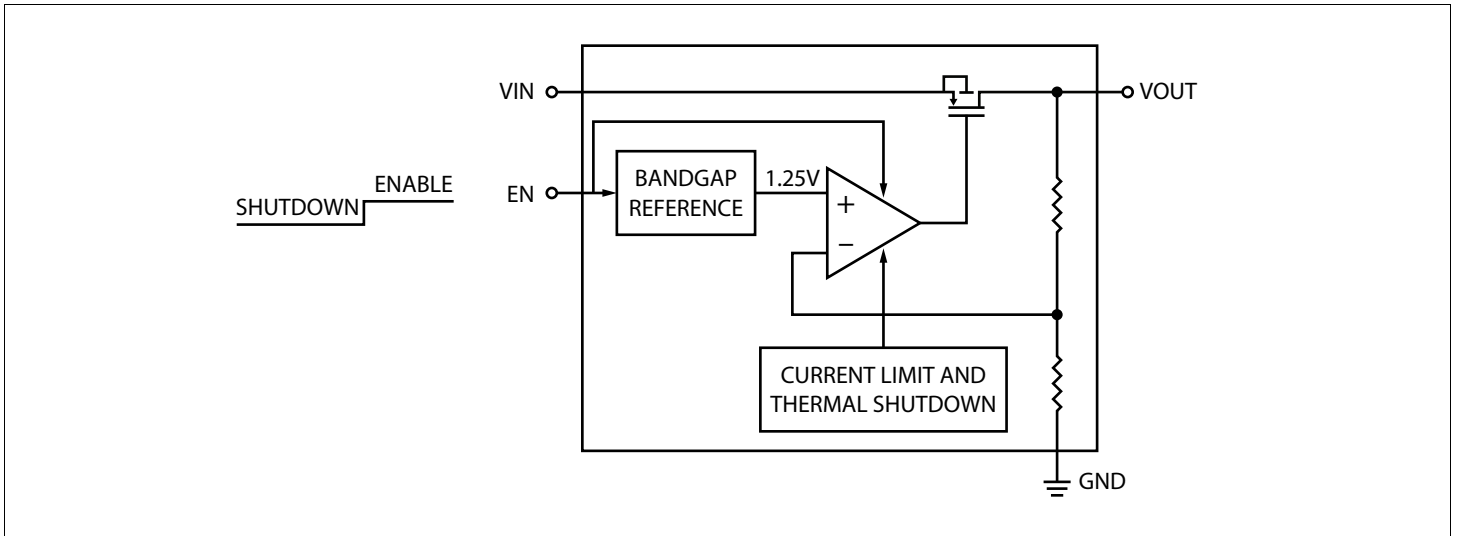

Figure 4: Functional Block Diagram

Application Information

SP6213 available, SP6214 obsolete

Enable/Shutdown Operation

The SP6213/14 is turned off by pulling the EN pin low and turned on by pulling it high. If this enable/shutdown feature is not required, EN should be tied to V_{IN} to keep the regulator output on at all times.

Input Capacitor

You can use any good quality ceramic or tantalum capacitor at the input. A small capacitor of about $1\mu\text{F}$ is required from V_{IN} to GND if, for instance, a battery is used as the input.

Output Capacitor

An output capacitor is required between V_{OUT} and GND to prevent oscillation. The minimum size of the output capacitor is a $0.47\mu\text{F}$ ceramic. The values given in the data sheet relate to an IC with a ceramic output capacitor of $1\mu\text{F}$. Larger values make the IC more stable, which means an improvement of the regulator's transient response. For a lower output current, the output capacitance can be chosen smaller in order to have the same output stability.

No Load Stability

The SP6213/14 remains stable and in regulation with no external load (other than the internal voltage driver), unlike many other voltage regulators. This is especially important in CMOS RAM keep-alive applications.

Thermal Considerations

The SP6213/14 is designed to provide 100mA of continuous current in a very tiny package. Maximum power dissipation can be calculated based on the output current and the voltage drop across the part. To determine the maximum power dissipation of the package, use the junction-to-ambient thermal resistance of the device and the following basic equation:

$$P_D = (T_{J(\text{MAX})} - T_A) / \theta_{JA}$$

$T_{J(\text{MAX})}$ is the maximum junction temperature of the die and is 125°C . T_A is the ambient operating temperature. θ_{JA} is the junction-to-ambient thermal resistance for the regulator and is layout-dependent. The actual power dissipation of the regulator circuit can be determined using one simple equation:

$$P_D = (V_{IN} - V_{OUT}) * I_{OUT} + V_{IN} * I_{GND}$$

Substituting $P_{D(\text{MAX})}$ for P_D and solving for the operating conditions that are critical to the application gives the maximum operating conditions for the regulator circuit. For example, if you are operating the SP6213/14 at 3.0V output at room temperature, with a minimum footprint layout, the maximum input voltage for a set output current can be determined as follows:

$$P_{D(\text{MAX})} = [(125^\circ\text{C} - 25^\circ\text{C}) / (330^\circ\text{C}/\text{W})] = 303\text{mW}$$

To prevent the device from entering thermal shutdown, the maximum power dissipation cannot be exceeded. Using the output voltage of 3.0V and an output current of 100mA, the maximum input voltage can be determined. You can find the ground pin current values in “[Electrical Characteristics](#)” on page 2 (0.135mA at 100mA load current).

The maximum input voltage is determined as follows:

$$303\text{mW} = (V_{IN} - 3.0\text{V}) * 100\text{mA load current} + V_{IN} * 0.135\text{mA}$$

Calculations show that the maximum input voltage of a 3.0V application at 100mA of output current in an SC70-5 package is 6.02V.

Typical Performance Characteristics

27°C, $V_{IN} = 4V$, $I_L = 100\mu A$, $C_{IN} = C_{OUT} = 1\mu F$, unless otherwise specified.

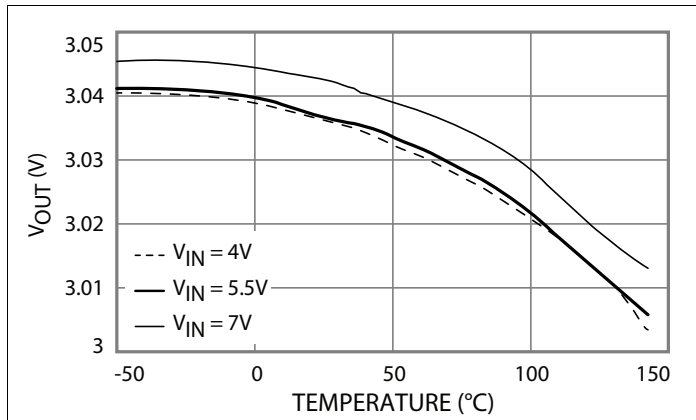

Figure 5: Output Voltage vs Temperature ($I_{OUT} = 0.1mA$)

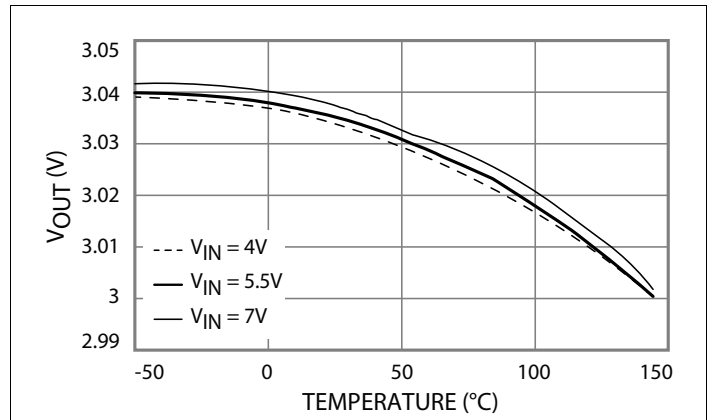

Figure 6: Output Voltage vs Temperature ($I_{OUT} = 10mA$)

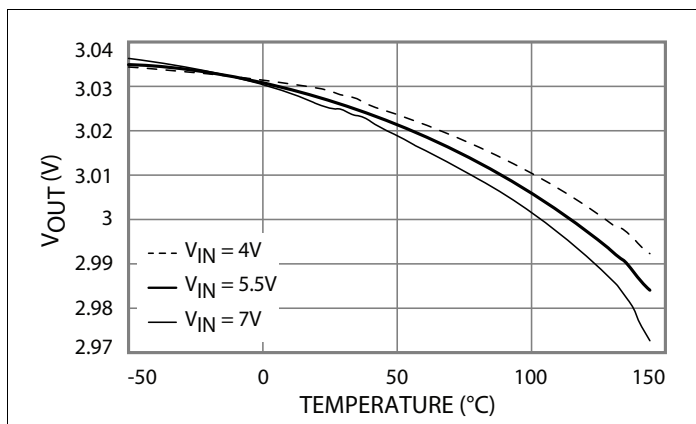

Figure 7: Output Voltage vs Temperature ($I_{OUT} = 50mA$)

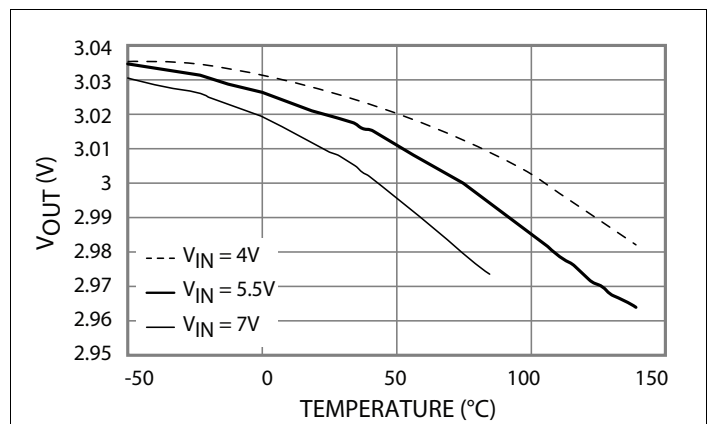

Figure 8: Output Voltage vs Temperature ($I_{OUT} = 100mA$)

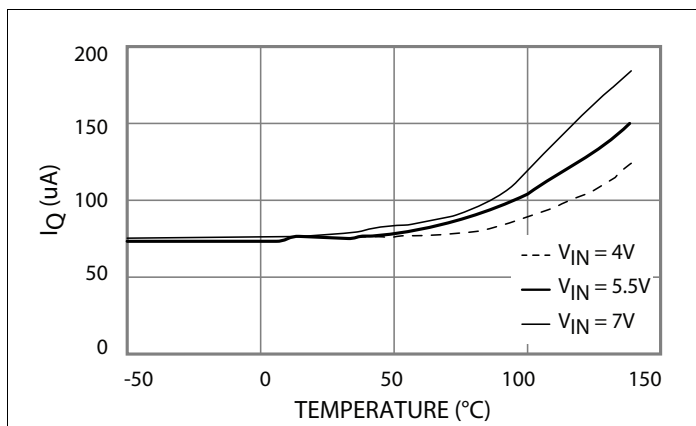

Figure 9: Quiescent Current vs Temperature ($I_{OUT} = 0A$)

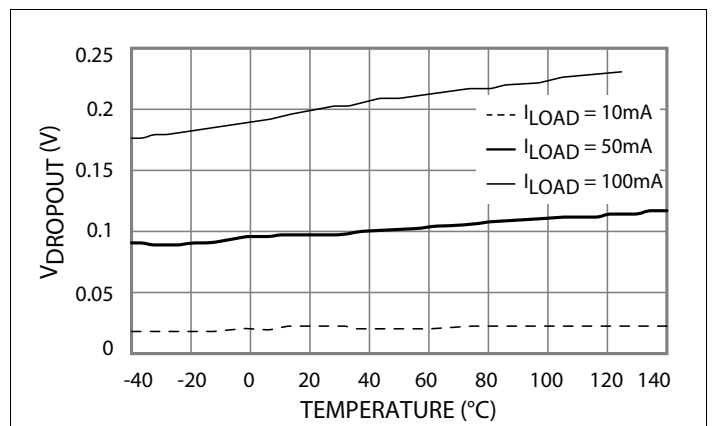

Figure 10: Dropout Voltage vs Temperature

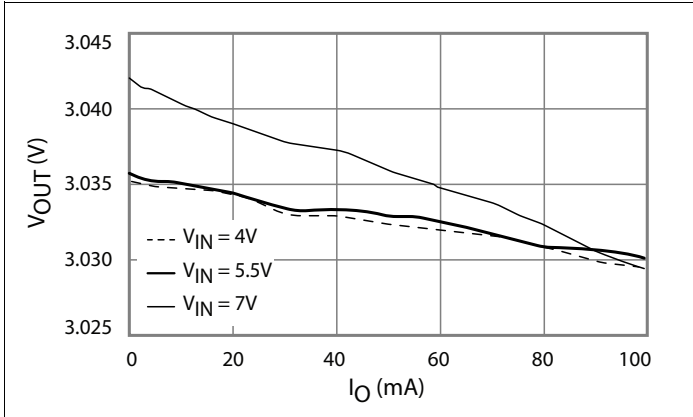

Figure 11: Output Voltage vs Output Current

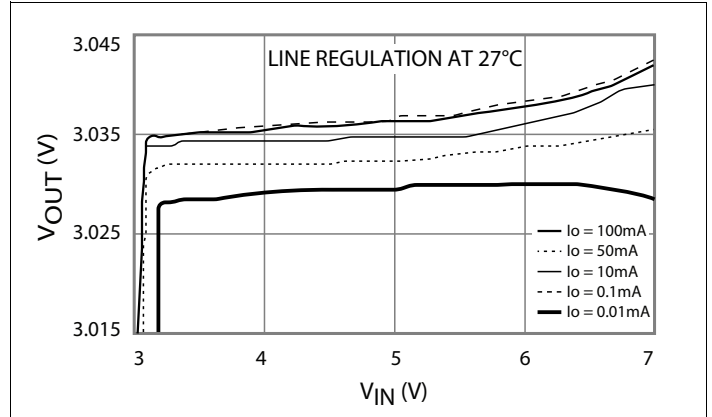

Figure 12: Output Voltage vs Input Voltage

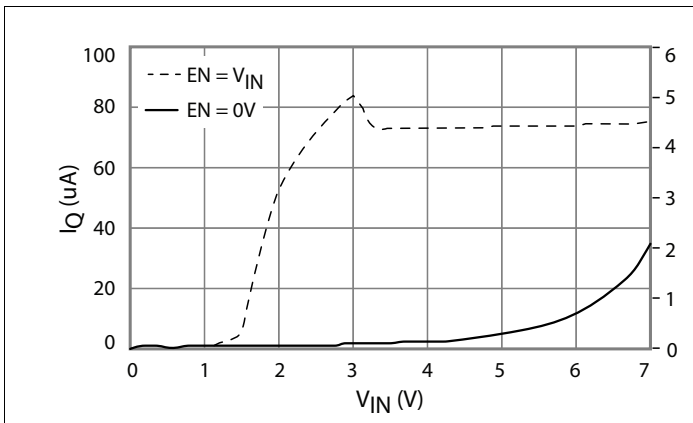

Figure 13: Quiescent Current vs Input Voltage

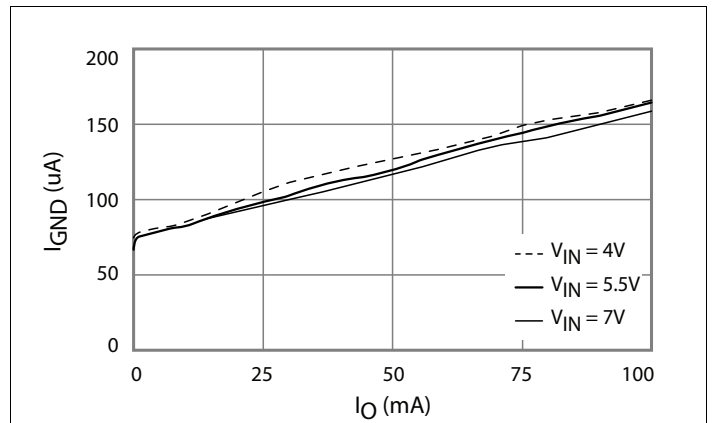

Figure 14: Ground Current vs Output Current

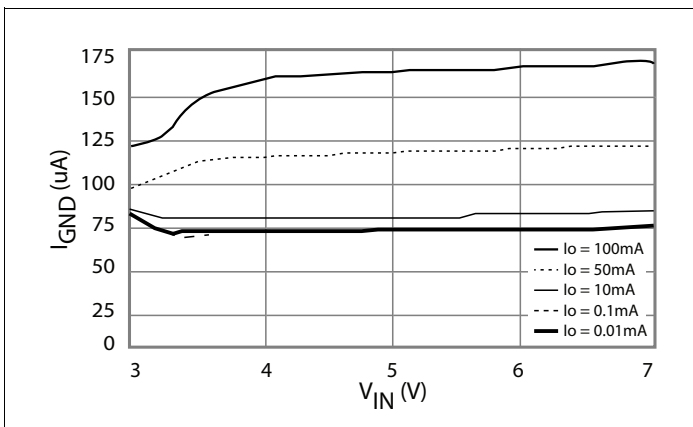

Figure 15: Ground Current vs Input Voltage

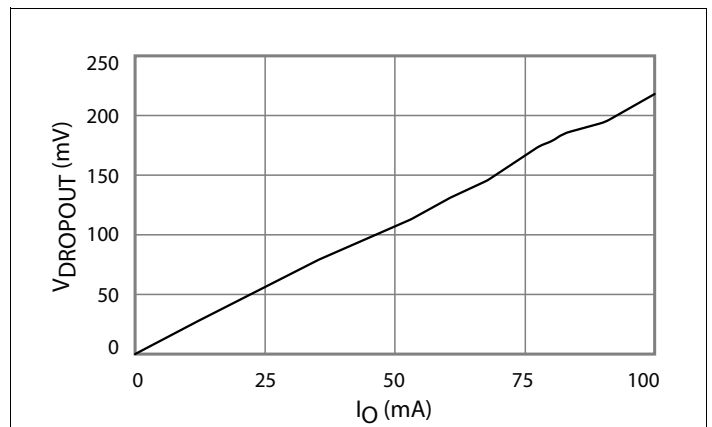

Figure 16: Dropout Voltage vs Output Current

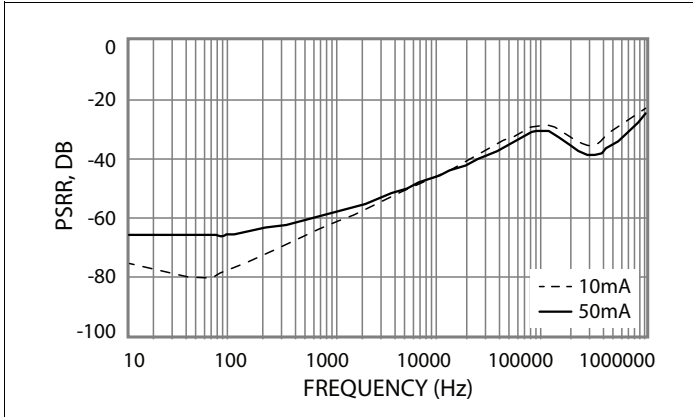

Figure 17: Power Supply Rejection Ratio ($V_O = 3V$)

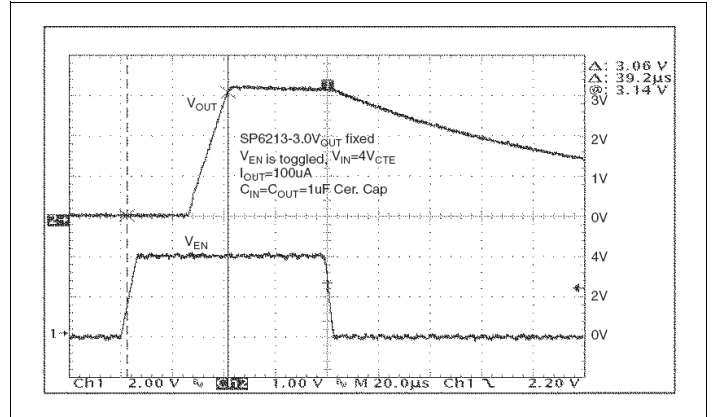

Figure 18: Turn-on Characteristic ($V_{IN} = 4V, I_{OUT} = 100\mu A$)

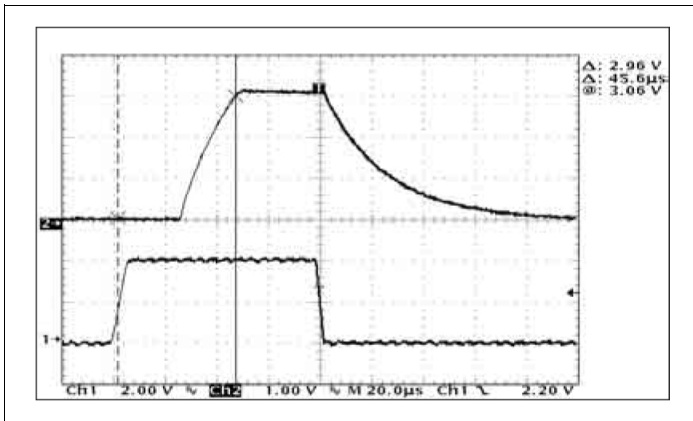

Figure 19: Turn-on Characteristic ($V_{IN} = 4V, I_{OUT} = 100mA$)

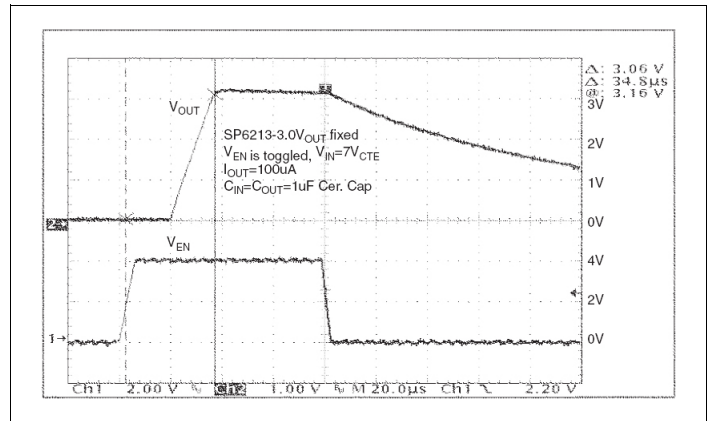

Figure 20: Turn-on Characteristic ($V_{IN} = 7V, I_{OUT} = 100\mu A$)

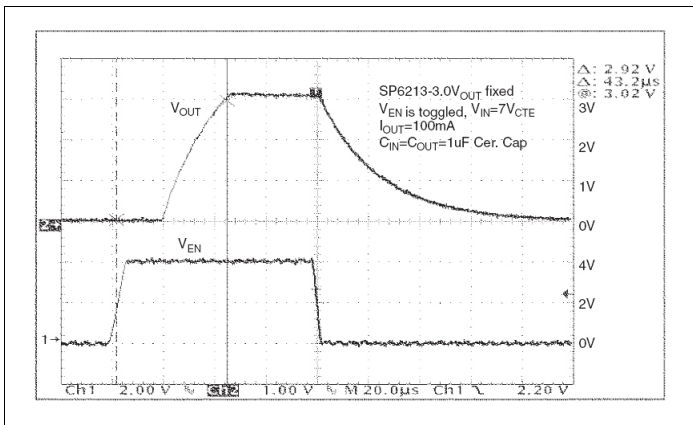

Figure 21: Turn-on Time ($V_{IN} = 7V, I_{OUT} = 100mA$)

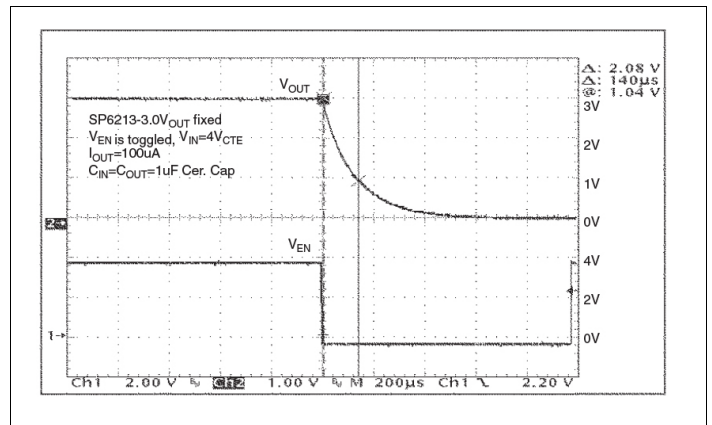

Figure 22: Turn-off Time ($V_{IN} = 4V, I_{OUT} = 100\mu A$)

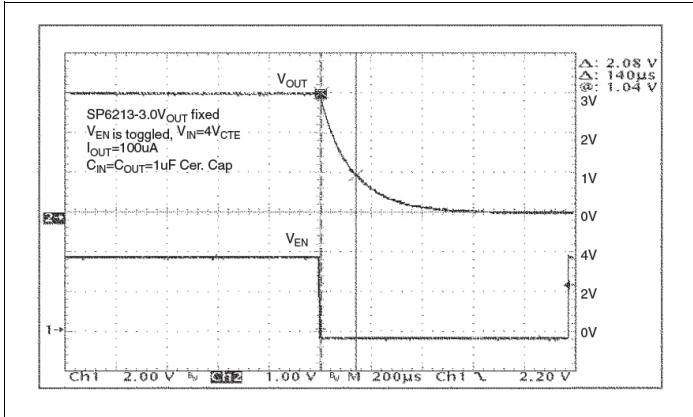

Figure 23: Turn-off Time ($V_{IN} = 4V$, $I_{OUT} = 100mA$)

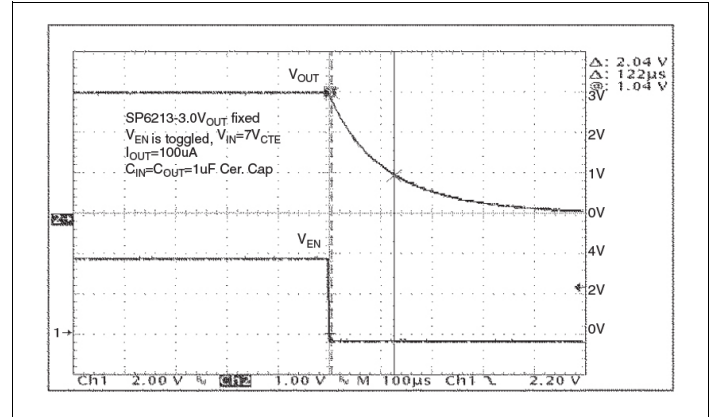

Figure 24: Turn-off Time ($V_{IN} = 7V$, $I_{OUT} = 100\mu A$)

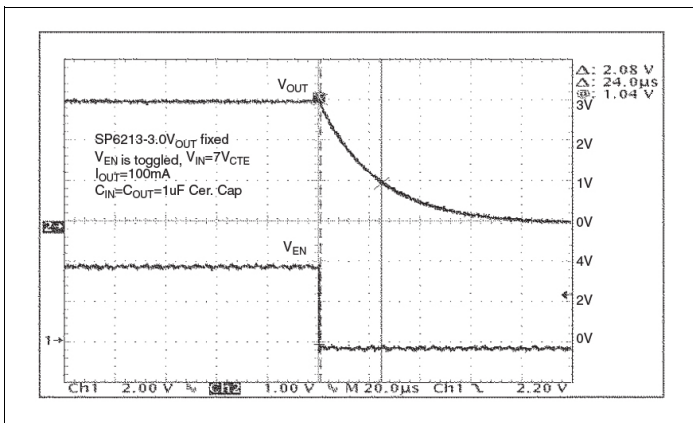

Figure 25: Turn-off Time ($V_{IN} = 7V$, $I_{OUT} = 100mA$)

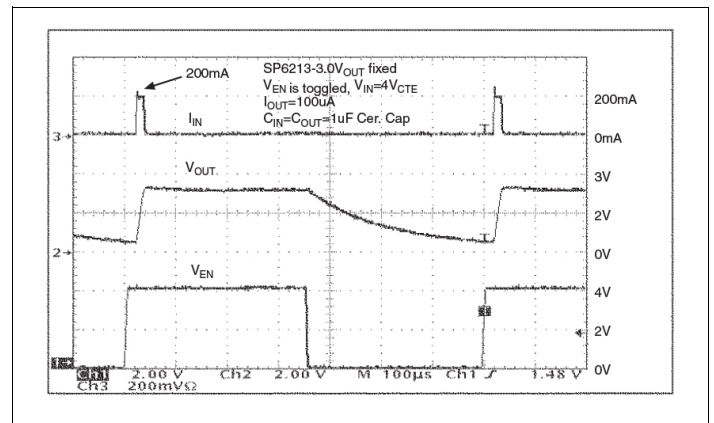

Figure 26: Inrush Current ($V_{IN} = 4V$, $I_{OUT} = 100\mu A$)

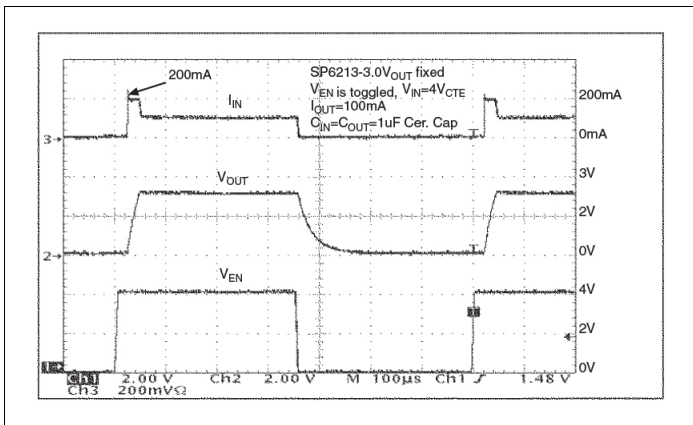

Figure 27: Inrush Current ($V_{IN} = 4V$, $I_{OUT} = 100mA$)

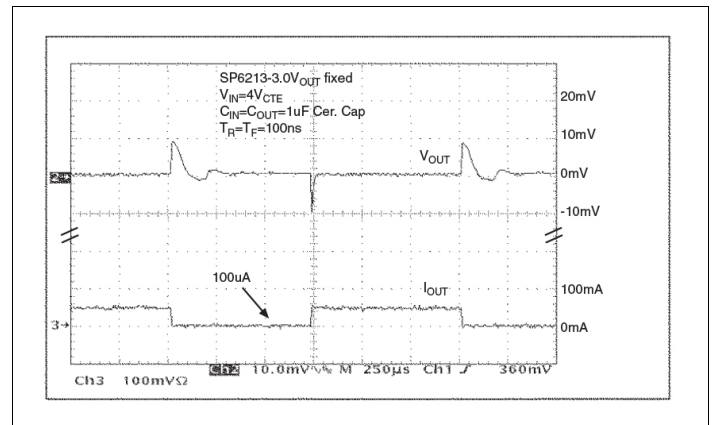

Figure 28: Load Transient Response ($V_{IN} = 4V$)

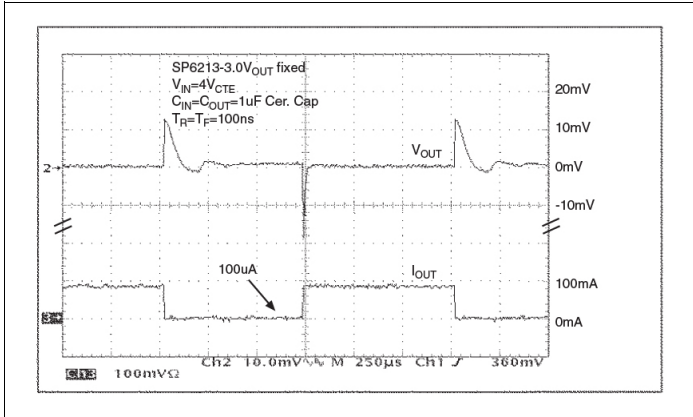

Figure 29: Load Transient Response ($V_{IN} = 4V$)

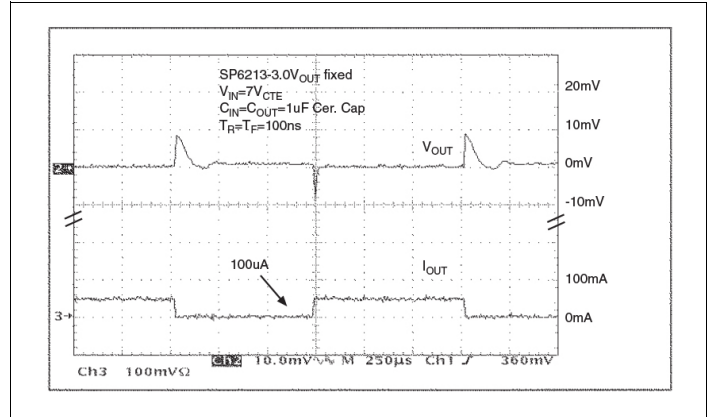

Figure 30: Load Transient Response ($V_{IN} = 7V$)

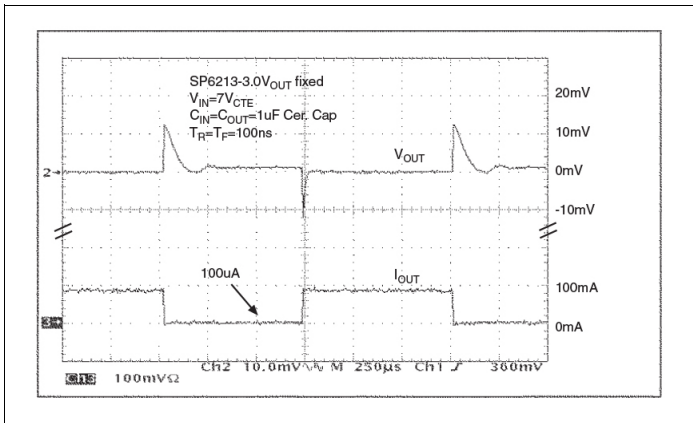

Figure 31: Load Transient Response ($V_{IN} = 7V$)

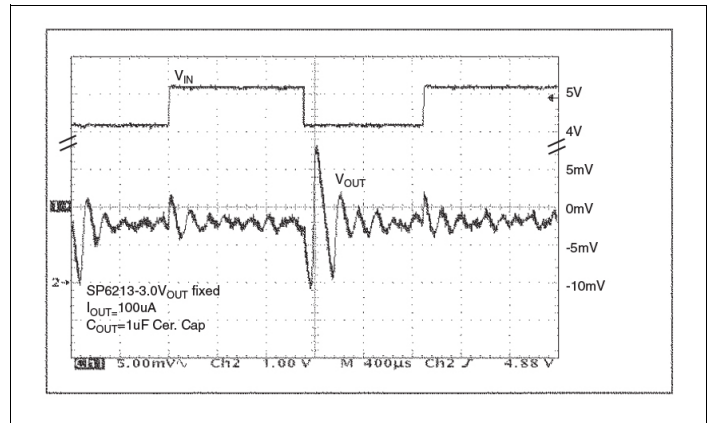

Figure 32: Line Transient Response ($V_{IN} = 4V, I_{OUT} = 100\mu A$)

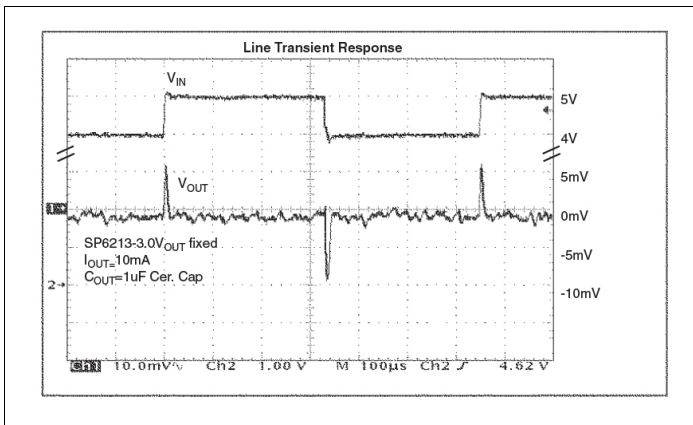

Figure 33: Line Transient Response ($V_{IN} = 4V, I_{OUT} = 10mA$)



Figure 34: Line Transient Response ($V_{IN} = 7V, I_{OUT} = 100\mu A$)

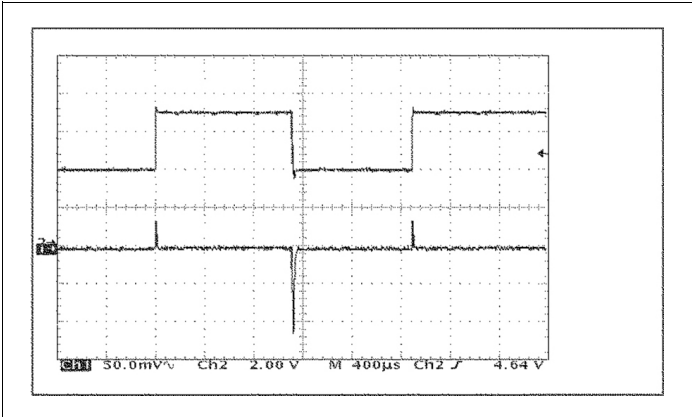

Figure 35: Line Transient Response ($V_{IN} = 7V$, $I_{OUT} = 10\mu A$)

Mechanical Dimensions

SC70-5

SP6213 available, SP6214 obsolete

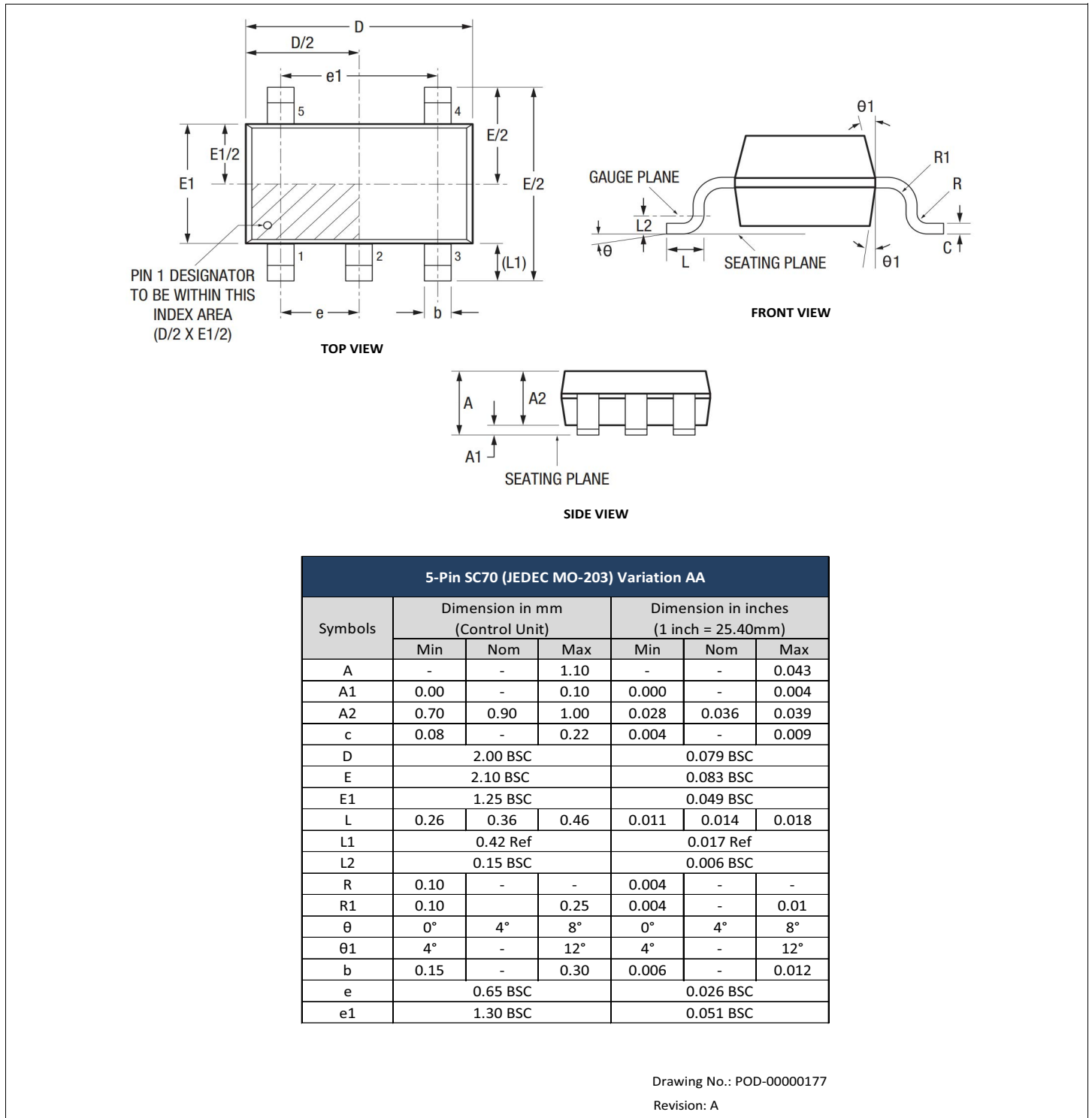

Figure 36: Mechanical Dimensions—SC70-5

Ordering Information

SP6213EC3 and SP6214 obsolete

Table 6: Ordering Information

Ordering Part Number	Operating Temperature Range	Accuracy	Output Voltage	Package	Packaging
SP6213EC5-L-3-3/TR	$-40^{\circ}\text{C} \leq T_J \leq 125^{\circ}\text{C}$	2%	3.3V	SC70-5	Tape and Reel

Note: For more information about part numbers, as well as the most up-to-date information and additional information on environmental rating, go to www.maxlinear.com/SP6213 and www.maxlinear.com/SP6214.



MaxLinear, Inc.
 5966 La Place Court, Suite 100
 Carlsbad, CA 92008
 Tel.: +1 (760) 692-0711
 Fax: +1 (760) 444-8598
www.maxlinear.com

The content of this document is furnished for informational use only, is subject to change without notice, and should not be construed as a commitment by MaxLinear, Inc. MaxLinear, Inc. assumes no responsibility or liability for any errors or inaccuracies that may appear in the informational content contained in this document. Complying with all applicable copyright laws is the responsibility of the user. Without limiting the rights under copyright, no part of this document may be reproduced into, stored in, or introduced into a retrieval system, or transmitted in any form or by any means (electronic, mechanical, photocopying, recording, or otherwise), or for any purpose, without the express written permission of MaxLinear, Inc.

EXCEPT AS OTHERWISE PROVIDED EXPRESSLY IN WRITING BY MAXLINEAR, AND TO THE MAXIMUM EXTENT PERMITTED BY LAW: (A) THE MAXLINEAR PRODUCTS ARE PROVIDED ON AN "AS IS" BASIS WITHOUT REPRESENTATIONS OR WARRANTIES OF ANY KIND, INCLUDING WITHOUT LIMITATION ANY IMPLIED OR STATUTORY WARRANTIES AND ANY WARRANTIES OF MERCHANTABILITY, FITNESS FOR A PARTICULAR PURPOSE, NON-INFRINGEMENT, OR TITLE; AND (B) MAXLINEAR DOES NOT GUARANTEE THAT THE PRODUCTS WILL BE FREE OF ERRORS OR DEFECTS. MAXLINEAR PRODUCTS SHOULD NOT BE USED IN ANY EMERGENCY, SECURITY, MILITARY, LIFE-SAVING, OR OTHER CRITICAL USE CASE WHERE A FAILURE OR MALFUNCTION COULD CAUSE PERSONAL INJURY OR DEATH, OR DAMAGE TO OR LOSS OF PROPERTY. USERS ASSUME ALL RISK FOR USING THE MAXLINEAR PRODUCTS IN SUCH USE CASE. CUSTOMERS AND USERS ARE SOLELY RESPONSIBLE FOR USING THEIR OWN SKILL AND JUDGMENT TO DETERMINE WHETHER MAXLINEAR PRODUCTS ARE SUITABLE FOR THE INTENDED USE CASE.

MaxLinear, Inc. may have patents, patent applications, trademarks, copyrights, or other intellectual property rights covering subject matter in this document. Except as expressly provided in any written license agreement from MaxLinear, Inc., the furnishing of this document does not give you any license to these patents, trademarks, copyrights, or other intellectual property.

MaxLinear, the MaxLinear logo, any other MaxLinear trademarks (including but not limited to MxL, Full-Spectrum Capture, FSC, AirPHY, Puma, AnyWAN, VectorBoost, MXL WARE, and Panther), and the MaxLinear logo on the products sold are all property of MaxLinear, Inc. or one of MaxLinear's subsidiaries in the U.S.A. and other countries. All rights reserved.

All third-party products, company names and logos are trademarks™ or registered® trademarks and remain the property of their respective holders/owners. Use of such marks does not imply any affiliation with, sponsorship or endorsement by the owners/holders of such trademarks. All references by MaxLinear to third party trademarks are intended to constitute nominative fair use under applicable trademark laws.

The URLs provided are for informational purposes only; they do not constitute an endorsement or an approval by MaxLinear of any of the products or services of the corporation or organization or individual. MaxLinear bears no responsibility for the accuracy, legality or content of the external site or for that of subsequent links. Contact the external site for answers to questions regarding its content.