

**GENERAL DESCRIPTION**

The XRP6274 is an ultra low dropout voltage regulator capable of delivering 2A output currents. It is unique in the industry in being able to operate from a single supply rail of 1.045V to 2.625V without the need for a noise generating charge pump.

With its ultra low dropout voltage of 140mV at full load guaranteed over temperature, the XRP6274 achieves conversions previously unavailable.

The output voltage can be set as low as 0.6V with $\pm 0.5\%$ accuracy making the XRP6274 perfectly suited for powering low voltage devices such as FPGAs, DSPs, ASICs, and other SOCs.

Built-in current limit, reverse bias and thermal protection ensures safe operation under abnormal operating conditions. An enable function, soft start and Power Good flag complete the feature set.

The XRP6274 is offered in RoHS compliant, "green"/halogen free 10-pin 3x3mm DFN package.

FEATURES

- **2A Output Current**
- **1.045V to 2.625V Single Input Voltage**
 - Adjustable Output Voltage $\geq 0.6V$
 - $\pm 0.5\%$ Output Voltage Accuracy
- **Ultra Low Dropout Voltage**
 - 140mV Max over temp @ 2A
- **Power Good Flag**
- **Enable & Soft Start**
- **Current Limit and Thermal Protection**
- **Reverse Bias Protection**
- **RoHS compliant "Green"/Halogen Free**
 - 10-pin 3mm x 3mm DFN

APPLICATIONS

- **Point of Load Conversion**
- **Microprocessors, DSPs, FPGAs Supplies**
- **Networking & Telecom Equipment**
- **Switching Supplies Post Regulation**

TYPICAL APPLICATION DIAGRAM

Fig. 1: XRP6274 Application Diagram



2A Ultra Low Dropout Voltage Regulator

ABSOLUTE MAXIMUM RATINGS

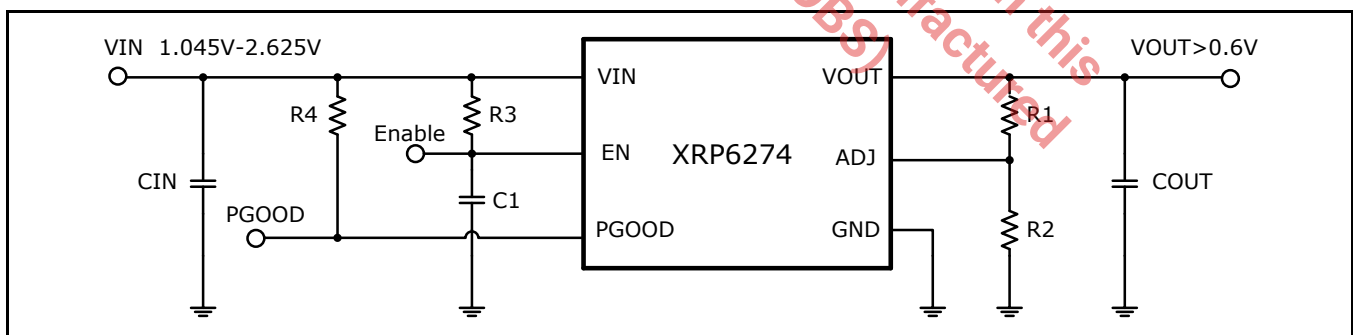
These are stress ratings only and functional operation of the device at these ratings or above any other of those indicated in the operation sections of the specifications below is not implied. Exposure to absolute maximum rating conditions for extended periods of time may affect reliability.

Input Voltage V_{IN} , V_{PGOOD} 3V
 Enable Voltage V_{EN} $V_{IN} + 0.5V \leq 3V$
 Storage Temperature -65°C to 150°C
 Junction Temperature 150°C
 Lead Temperature (Soldering, 5 sec) 260°C
 ESD Rating (HBM - Human Body Model) 2kV
 ESD Rating (CDM - Charged Device Model) 1kV

Operating Ratings

Input Voltage Range V_{IN} , V_{EN} , V_{PGOOD} 1.045V-2.625V
 Junction Temperature Range -40°C to 125°C
 Thermal Resistance θ_{JC} DFN10 6°C/W
 Thermal Resistance θ_{JA} DFN10 40.5°C/W

ELECTRICAL SPECIFICATIONS

Specifications are for an Operating Junction Temperature of $T_J = T_A = 25^\circ C$ only; limits applying over the full Operating Junction Temperature range are denoted by a “•”. Typical values represent the most likely parametric norm at $T_J = 25^\circ C$, and are provided for reference purposes only. Unless otherwise indicated, $V_{IN} = V_{OUT} + 0.5V$ and $I_{OUT} = 20mA$, $C_{IN} = 47\mu F$, $C_{OUT} = 47\mu F$, $T_A = 25^\circ C$.

Parameter	Min.	Typ.	Max.	Units	Conditions
Input Voltage Operating Range	1.045		2.625	V	•
Maximum Output Current ¹	2			A	
Ground Current		2.0		mA	EN active
		2.5	6.0	mA	EN active, $I_{OUT} = 2$
Shutdown Current		12		μA	$V_{EN} = 0V$, $I_{OUT} = 0mA$, PGOOD Floating
ADJ Pin Voltage	598.5	601.5	604.5	mV	• $V_{IN} = 2.5V$, $V_{OUT} > 1V$
	594.0		606.0	mV	
	597.0	600.0	603.0	mV	
	592.0		605.0	mV	
	596.0	599.0	602.0	mV	
	590.7		604.0	mV	• $V_{IN} = 1.35V$
Dropout Voltage			140	mV	• $I_{OUT} = 2A$, $V_{OUT} = 1.0V$ (Note 2)
Output Voltage Load Regulation			0.25	%	$V_{IN} = V_{OUT} + 0.5V$, $20mA \leq I_{OUT} \leq 2A$
Power Supply Rejection Ratio (PSRR)		35		dB	$f = 1kHz$
		30		dB	$f > 300kHz$
Output Noise Voltage		200		μV_{RMS}	10Hz-100kHz
Current Limit	2.1		4.4	A	• $V_{OUT} = 0.9 \times V_{OUT(NOM)}$
Reverse Bias Protection V_{OUT} Leakage current		-10		μA	$V_{IN} = 0V$, $V_{OUT} = 2.625V$
Thermal Shutdown Temperature		160		$^\circ C$	
Thermal Shutdown Hysteresis		30		$^\circ C$	
Start Up time		2		ms	$V_{OUT} = 1.0V$
Power Good Threshold	92	94	97	% of V_{OUT}	• V_{OUT} rising
Power Good Threshold Hysteresis		2.8		% of V_{OUT}	V_{OUT} falling
PGOOD Output Low			0.4	V	• $V_{IN} > 1.5V$, $I_{SINK} = 1mA$
			0.4	V	• $V_{IN} > 1.045V$, $I_{SINK} = 100\mu A$



2A Ultra Low Dropout Voltage Regulator

Parameter	Min.	Typ.	Max.	Units	Conditions
Enable Pin Specifications					
Enable Threshold Voltage	0.43	0.55	0.67	V	• V_{EN} rising
EN Sink Current		2.5		μ A	$EN < V_{IN}$
		15		μ A	$V_{IN} < EN < V_{IN} + 0.5V$
Maximum Allowable EN Sink Current			100 μ A	μ A	$EN = V_{IN} + 0.5V$ (when using internal clamp)
EN Source Current			10	μ A	$EN = 0V$

Note 1: The XRP6274 is rated over a junction temperature range T_J of $-40^{\circ}C$ to $+125^{\circ}C$. For a given set of operating conditions, T_J has to be calculated in order to make sure it does not exceed maximum specification. Use equation $T_J = T_A + (P_D \cdot \theta_{JA})$ where θ_{JA} is the package thermal impedance, T_A is the ambient temperature and P_D is power dissipation. P_D is calculated from $P_D = (V_{IN} - V_{OUT}) \cdot I_{OUT}$

Note 2: Dropout voltage is defined as the input to output voltage differential ($V_{IN} - V_{OUT}$) where the input voltage is low enough to cause the output voltage to drop 2% from the nominal value.

BLOCK DIAGRAM

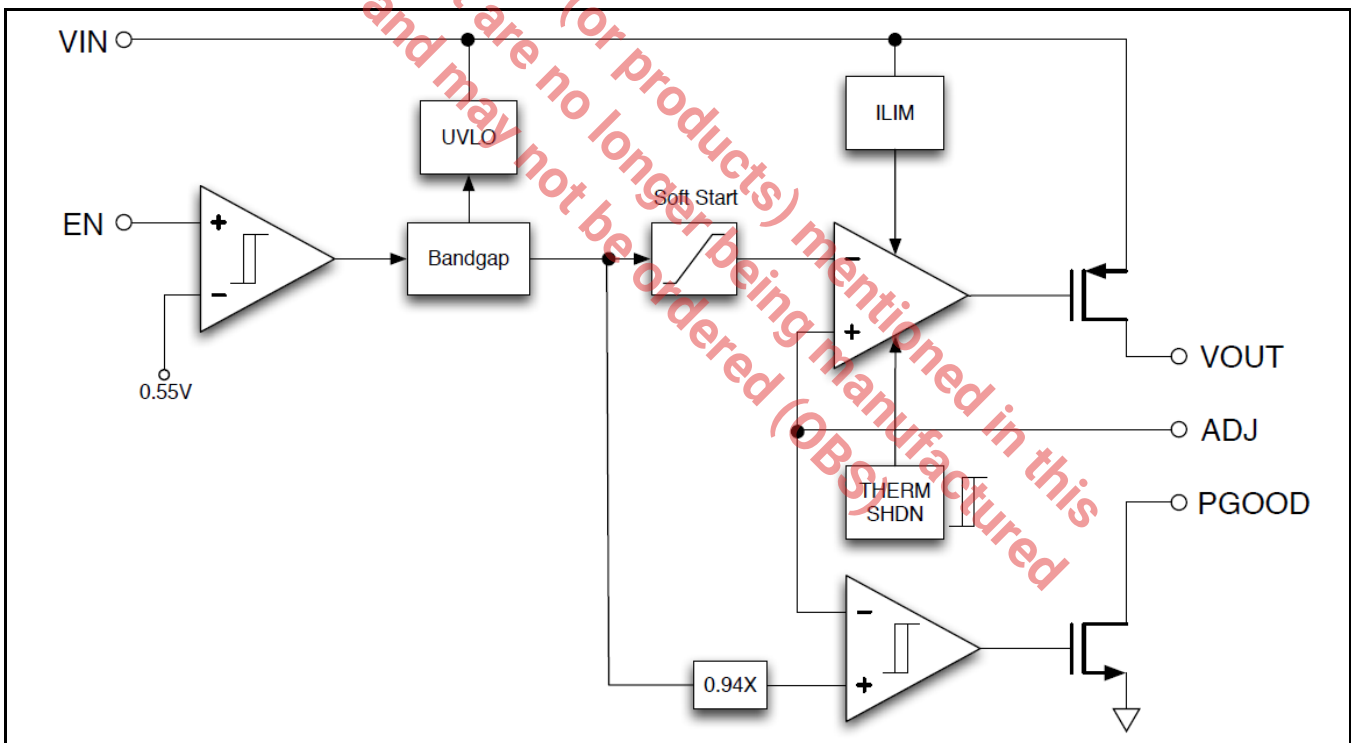

Fig. 2: XRP6274 Block Diagram



PIN ASSIGNMENT

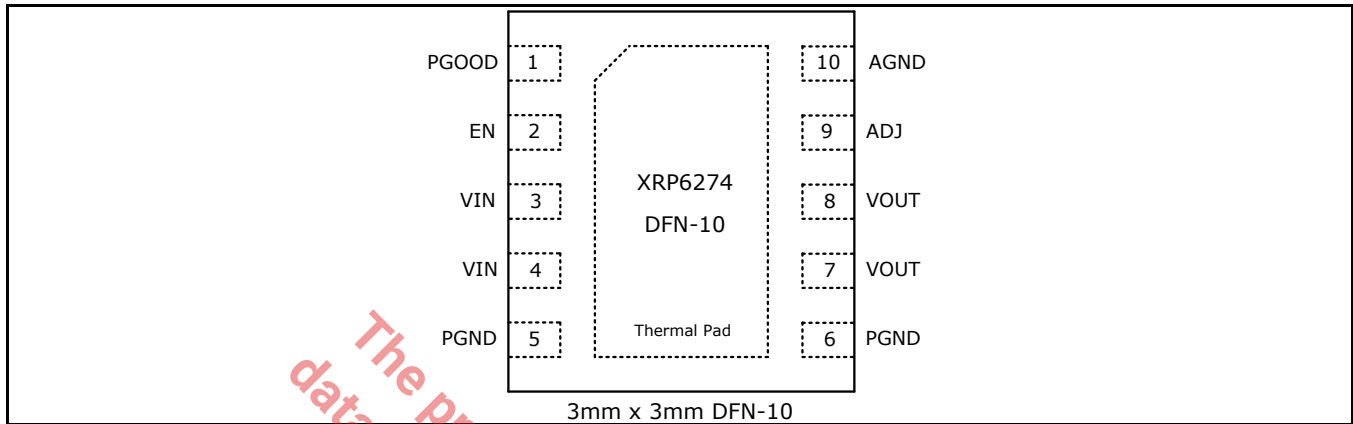

Fig. 3: XRP6274 Pin Assignment

PIN DESCRIPTION

Name	PIN #	Description
EN	2	Enable Input Pin. This is a high impedance MOS input with CMOS logic level compatibility. Logic high enables the device; logic low disables the device. EN must be asserted high after VIN reaches its minimum operating range. For automatic startup EN must be sequenced with respect to VIN as shown in application circuit. Do not pull this pin higher than VIN+0.5V.
VIN	3, 4	Power Input Pin. Must be closely decoupled to PGND pin with a 4.7µF or greater ceramic capacitor.
PGOOD	1	Power Good open Drain Output. When used it should be pulled up to VIN with a resistor. Typical resistor value 100k.
VOUT	7, 8	Regulator Output pin. Must be closely decoupled to PGND pin with a 4.7µF or greater ceramic capacitor.
ADJ	9	Adjustable Pin. Connect to a resistive voltage divider to set the output voltage of the device.
PGND	5, 6	Power Ground
Ther. Pad	---	Connect to PGND.
AGND	10	Signal ground. Connect with a separate trace to the ground of the output being regulated.

ORDERING INFORMATION

Part Number	Junction Temperature Range	Marking	Package	Packing Quantity	Note 1	Note 2
XRP6274EH-F	-40°C ≤ T _j ≤ +125°C	6274E	10-pin DFN	Bulk	Halogen Free	3Amp Adjustable
XRP6274EHMTR-F		YYWW		250/Tape & Reel		
XRP6274EHTR-F		XXXXX		3K/Tape & Reel		
XRP6274EVB	XRP6274 Evaluation board					

“YY” = Year – “WW” = Work Week – “X” = Lot Number when applicable.



TYPICAL PERFORMANCE CHARACTERISTICS

All data taken at $V_{IN} = V_{OUT} + 0.5V$, $T_J = T_A = 25^\circ C$, unless otherwise specified - Schematic and BOM from Application Information section of this datasheet.

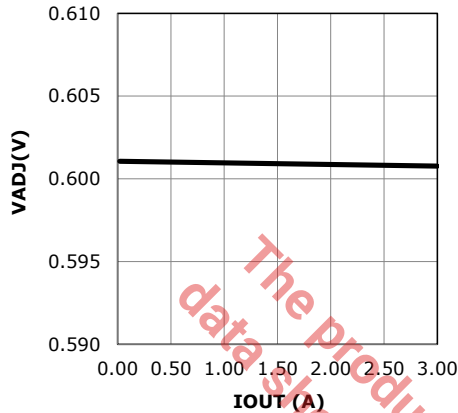

Fig. 4: VADJ versus IOUT, 1.5VIN, 1VOUT

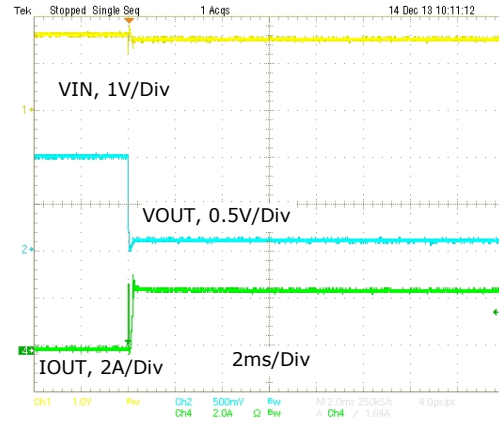

Fig. 5: Short-circuit, 1.5VIN, 1VOUT

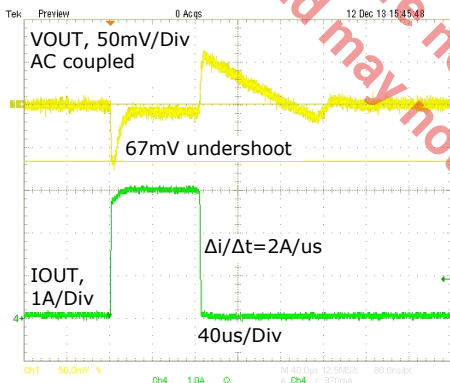

Fig. 6: Transient response, 20mA-3A, 1.5VIN, 1VOUT

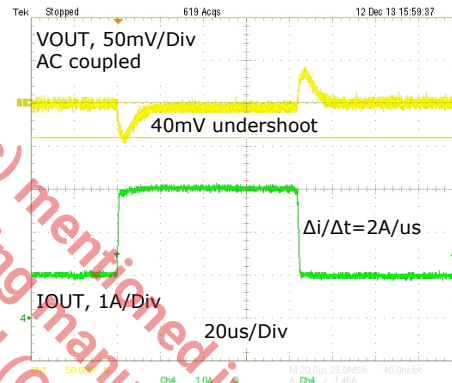

Fig. 7: Transient response, 1A-3A, 1.5VIN, 1VOUT

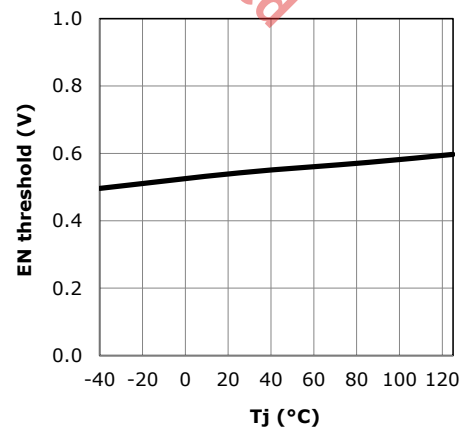

Fig. 8: Enable threshold versus temperature

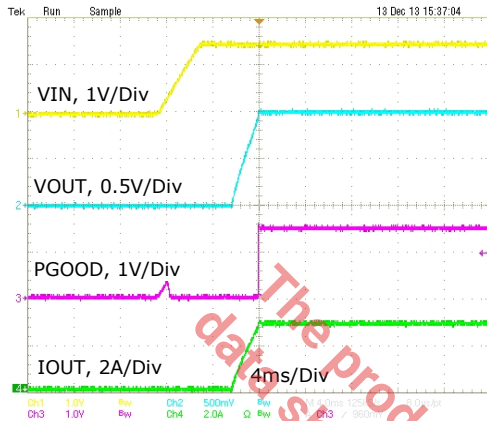

Fig. 9: Powerup, IOUT=3A, 1.5VIN, 1VOUT

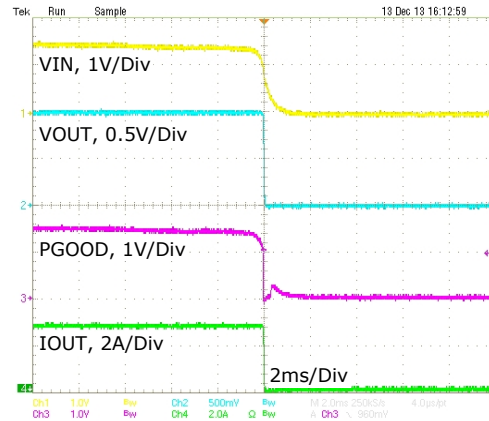

Fig. 10: Powerdown, IOUT=3A, 1.5VIN, 1VOUT

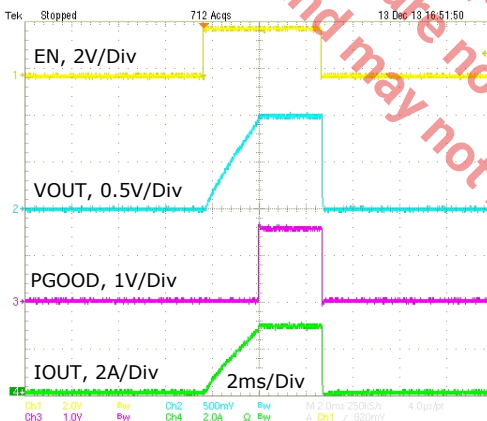

Fig. 11: Enable turn on/off, 3A, 1.5VIN, 1VOUT

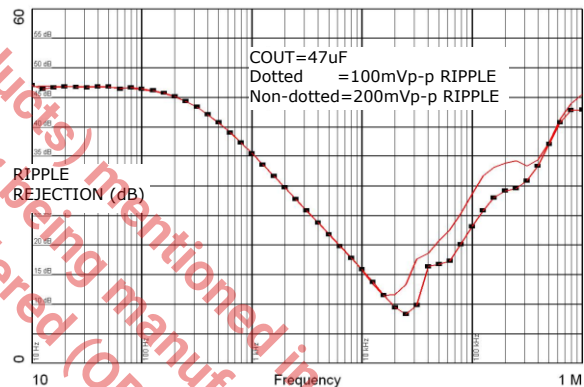

Fig. 12: PSRR, 50mA, 1.5VIN, 1VOUT, 47uF COUT

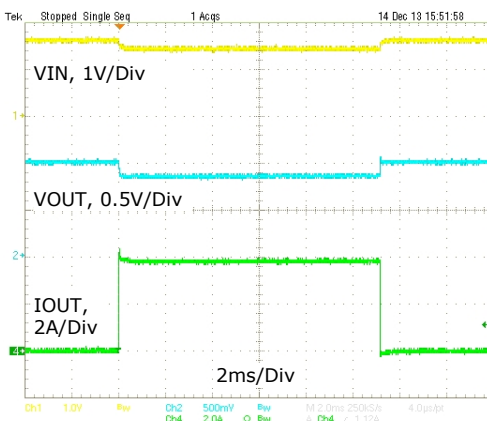

Fig. 13: Current limit, 1.5VIN, 1VOUT



2A Ultra Low Dropout Voltage Regulator

THEORY OF OPERATION

SINGLE RAIL INPUT VOLTAGE

The XRP6274's ultra low input voltage allows single rail operation from 2.625V down to 1.045V without requiring any extra biasing voltage. This single input voltage range provides easy conversions from industry standard 1.1V, 1.2V, 1.35V, 1.5V, 1.8V and 2.5V power rails.

DROPOUT VOLTAGE

The dropout voltage is the input-to-output differential voltage at which the XRP6274 ceases to regulate against further reductions in input voltage; this point occurs when the input voltage approaches the output voltage. The XRP6274 provides ultra low industry leading dropout voltage performance making it the perfect solution for high current extremely tight input/output voltage conversions. This extremely low dropout voltage allows high efficiencies conversions.

Below tables illustrate the achievable conversions for different load requirements for the XRP6274.

2A	Output Voltage								
	1.80	1.50	1.35	1.20	1.10	1.00	0.90	0.80	0.60
2.50	Yes	Yes	Yes	Yes	Yes	Yes	Yes	Yes	Yes
1.80		Yes	Yes	Yes	Yes	Yes	Yes	Yes	Yes
1.50			No	Yes	Yes	Yes	Yes	Yes	Yes
1.35				No	Yes	Yes	Yes	Yes	Yes
1.20					No	Yes	Yes	Yes	Yes
1.10						No	Yes	Yes	Yes

Note: Yellow indicates conversions that may be thermally limited

The maximum output current available for a given conversion is dependent on the operating conditions and thermal performance of DFN10/PCB (see note 1 on page 3).

SETTING THE OUTPUT VOLTAGE

The XRP6274 is an adjustable regulator that can be programmed to any value between 0.6V and 2.4V using 2 external resistors, R1 and R2. The relationship between the resistors and the output voltage is:

$$R_1 = R_2 \times \left(\frac{V_{OUT}}{0.6} - 1 \right)$$

where V_{OUT} is the desired output voltage.

Sum of resistors R1 and R2 must meet the following requirement:

$$\frac{V_{OUT}}{R_1 + R_2} \geq 20mA$$

INPUT AND OUTPUT CAPACITORS

The XRP6274 is designed to be stable for all available types and values of output capacitors greater than 4.7µF.

The required capacitance on the V_{IN} and V_{OUT} pins strongly depends on the input supply source impedance; the minimum recommended capacitor for V_{IN} is 4.7µF. Low ESR ceramic X5R and X7R capacitors are recommended and should be placed as close as possible to the pins for optimal performance.

Because of the low voltages and high currents supported by this device, typical values of 47uF for both input and output capacitors are recommended when powering high speed digital circuits.

ENABLE INPUT AND SHUTDOWN

The enable pin (EN) can be used to shut down the XRP6274. Connecting this pin to ground signal or to a voltage less than typical 0.55V will completely turn off the regulator. Pulling the EN above 0.67V enables the XRP6274. Where EN is derived from V_{IN} it must be sequenced with respect to V_{IN} as shown in the application circuit. Where an independent control signal is applied to EN, it must be asserted high after V_{IN} reaches its minimum operating range.

The enable pin is a high impedance MOS input. In order to allow the EN pin compatibility with 5V or 3.3V control signals, there is an internal clamp set to $V_{IN}+0.5V$. When using the EN pin with a control signal greater than $V_{IN}+0.5V$, a resistor must be placed in series with the EN pin to limit the input current below 100uA. The resistor must also be low enough to ensure at least 15uA can be sourced to enable the part.

The precision feature enables simple sequencing of multiple power supplies with a resistor divider from another power supply or power good flag. The EN pin can also be used as an external UVLO to disable the part when

**2A Ultra Low Dropout Voltage Regulator**

input voltage falls below a lower boundary of operation.

SOFT START

The XRP6274 features a soft-start which controls the output voltage ramp and allows the regulator to gradually reach the initial steady state operating point. This reduces current spikes and surges at start up due to output capacitor inrush current. Internal sequencing completes in 50us, and then the reference voltage is linearly ramped over a period of approximately 2ms.

The inrush current will be the lesser of the current limit value or the current defined by the equation below:

$$I_{INRUSH} = C_{OUT} \frac{V_{OUT}}{2000\mu s}$$

POWER GOOD FLAG

The XRP6274 features a Power Good Flag output signaling an abnormal operating condition. A low voltage on the Power Good Flag output indicates:

- Output voltage V_{OUT} is approximately 9% below its expected value
- A thermal fault has occurred

The Power Good Flag output, is an open collector capable of sinking in excess of 1mA.

OUTPUT CURRENT LIMIT PROTECTION

The XRP6274 integrates output current limit protection in order to protect the system main power supply, the regulator itself and the load from excessive current flow. This current limit

effectively keeps the flow of current in the circuit at a safe level.

In short circuit conditions, the device will take additional steps to limit input and power by disabling and re-enabling the pass device until the short condition is removed and normal operation can resume. Depending on the impedance of the short, this short circuit protection function may initiate operation between 10% and 50% of the targeted output voltage

THERMAL PROTECTION AND SHUTDOWN

The XRP6274 includes a thermal shutdown circuitry in order to restrict the device's operating temperature within a safe operating range. When activated, typically at 160°C, the XRP6274 is forced into a low power reset state with a typical hysteresis of 30 degrees.

Combined with the short circuit current protection, it reduces and limits the heating effects of over-temperature and/or over-current conditions on the LDO and surrounding circuits.

REVERSE BIAS PROTECTION

In addition to the standard protection features in these devices, they also incorporate a reverse bias protection. Most LDOs have a parasitic body diode that provides a path from V_{OUT} to V_{IN} if the input is shorted to ground. The XRP6274 has a blocking diode to ensure that no high discharge currents can occur between the output and the input when the input is shorted to ground.



TYPICAL APPLICATION CIRCUIT

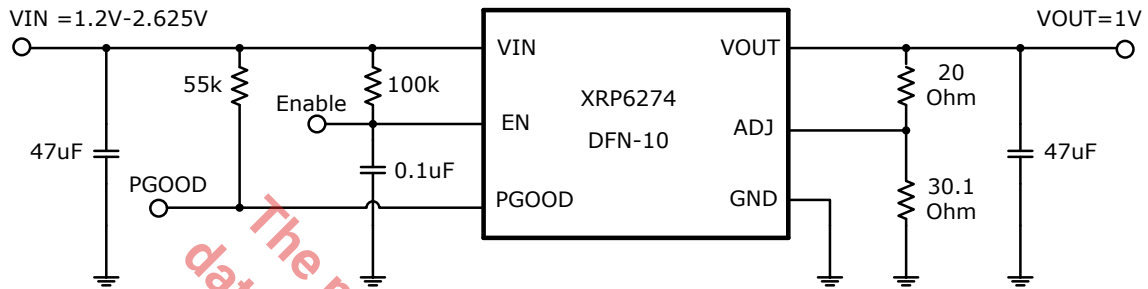

Fig. 14: XRP6274 Typical Application Diagram

The product (or products) mentioned in this data sheet are no longer being manufactured and may not be ordered (OBS)



PACKAGE SPECIFICATION

10-PIN 3MM X 3MM DFN

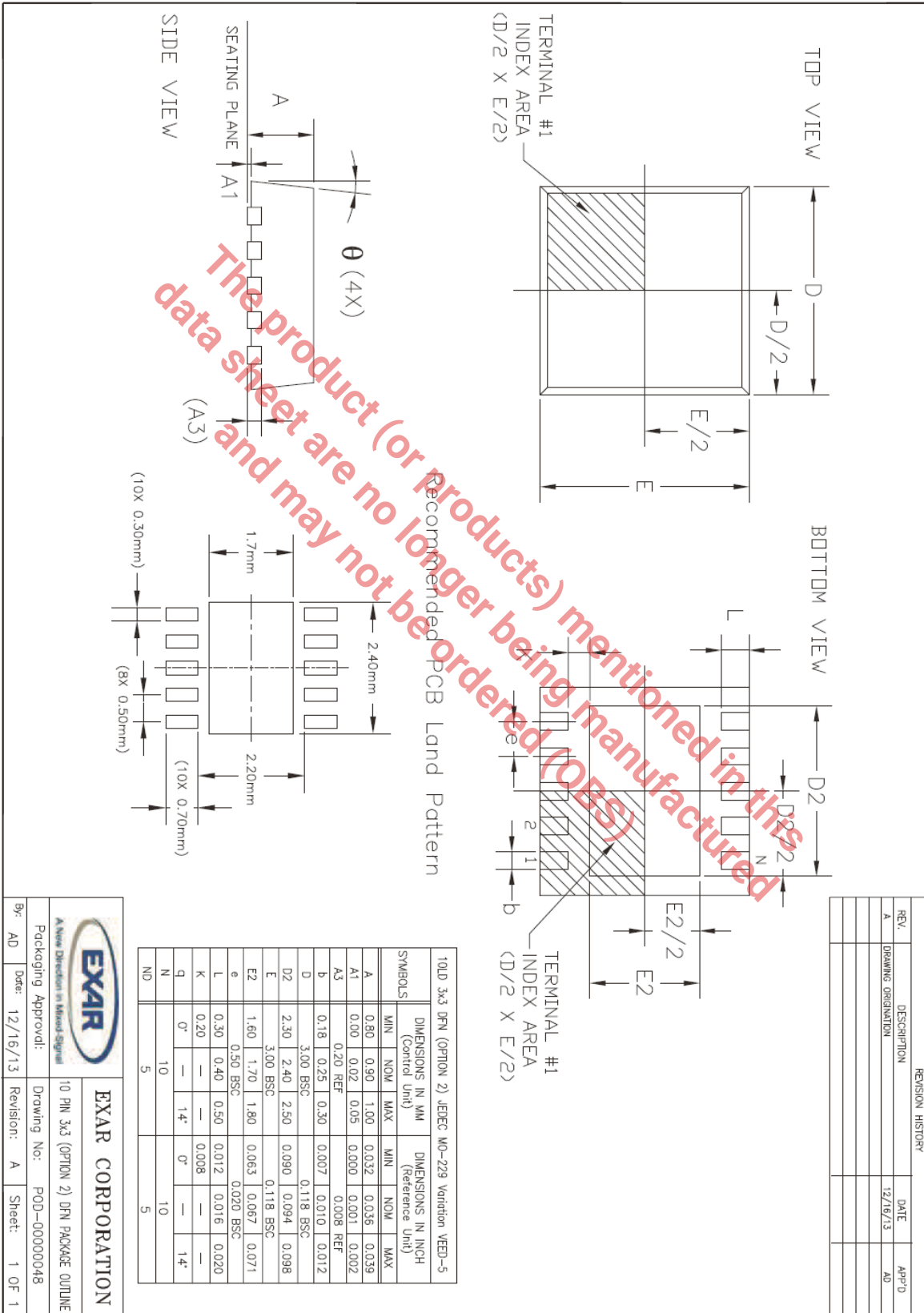

The product (or products) mentioned in this data sheet are no longer being manufactured (OBS)

REVISION HISTORY			
REV.	DESCRIPTION	DATE	APP'D
A	DRAWING ORIGINATION	12/16/13	AD

By: AD	Date: 12/16/13	Revision: A	Sheet: 1 OF 1
--------	----------------	-------------	---------------

ECN: 1361-12	12/17/2013
--------------	------------

	EXAR CORPORATION A New Direction in Mixed-Signal
Packaging Approval:	Drawing No: FOD-00000048
10 PIN 3x3 (OPTION 2) DFN PACKAGE OUTLINE	



FOR FURTHER ASSISTANCE

Email:

customersupport@exar.com

powertechsupport@exar.com

Exar Technical Documentation:

<http://www.exar.com/TechDoc/default.aspx?>



EXAR CORPORATION

HEADQUARTERS AND SALES OFFICES

48720 Kato Road

Fremont, CA 94538 – USA

Tel.: +1 (510) 668-7000

Fax: +1 (510) 668-7030

www.exar.com

NOTICE

EXAR Corporation reserves the right to make changes to the products contained in this publication in order to improve design, performance or reliability. EXAR Corporation assumes no responsibility for the use of any circuits described herein, conveys no license under any patent or other right, and makes no representation that the circuits are free of patent infringement. Charts and schedules contained herein are only for illustration purposes and may vary depending upon a user's specific application. While the information in this publication has been carefully checked; no responsibility, however, is assumed for inaccuracies.

EXAR Corporation does not recommend the use of any of its products in life support applications where the failure or malfunction of the product can reasonably be expected to cause failure of the life support system or to significantly affect its safety or effectiveness. Products are not authorized for use in such applications unless EXAR Corporation receives, in writing, assurances to its satisfaction that: (a) the risk of injury or damage has been minimized; (b) the user assumes all such risks; (c) potential liability of EXAR Corporation is adequately protected under the circumstances.

Reproduction, in part or whole, without the prior written consent of EXAR Corporation is prohibited.