

General Description

The MxL7213 is a dual channel, 13A step-down power module. It includes a wide 4.5V to 16V input voltage range and supports two outputs each with an output voltage range of 0.6V to 5.3V, set by a single external resistor. The MxL7213 requires just a few input and output capacitors, which simplifies design and shortens time-to-market. The module supplies either two 13A outputs, a single 26A or up to 100A when paralleled with additional MxL7213 modules. Attention to thermal design, component selection and internal construction results in higher efficiency and extended operating range relative to devices with the same industry standard pinout.

The complete switch mode DC/DC power supply integrates the control, drivers, bootstrap diodes, bootstrap capacitors, inductors, MOSFETs and HF bypass capacitors in a single package for point-of-load conversions.

The MxL7213 includes a temperature diode that enables device temperature monitoring. It also has an adjustable switching frequency and utilizes a peak current mode architecture which allows fast line and load transient response.

A host of protection features, including overcurrent, over-temperature, short-circuit and UVLO, help this module achieve safe operation under abnormal operating conditions.

The MxL7213 is available in two space saving, RoHS compliant and thermally enhanced packages: a 15mm x 15mm x 4.41mm LGA package and a 15mm x 15mm x 5.01mm BGA package.

Features

- Dual 13A or single 26A output
- Input voltage range: 4.5V to 16V
- Output voltage range: 0.6V to 5.3V
- Multiphase current sharing with multiple MxL7213s for up to 100A output
- Frequency synchronization
- Higher efficiency than competitive devices with the same industry standard pinout
- Differential remote sense amplifier
- Peak current mode architecture for fast transient response
- Adjustable switching frequency (250kHz to 780kHz)
- Overcurrent protection
- Output overvoltage protection
- Internal temperature monitor and thermal shutdown protection
- Thermally enhanced packages:
 - 15mm x 15mm x 4.41mm LGA package
 - 15mm x 15mm x 5.01mm BGA package

Applications

- Telecom and Networking Equipment
- Industrial Equipment
- Test Equipment

Typical Application

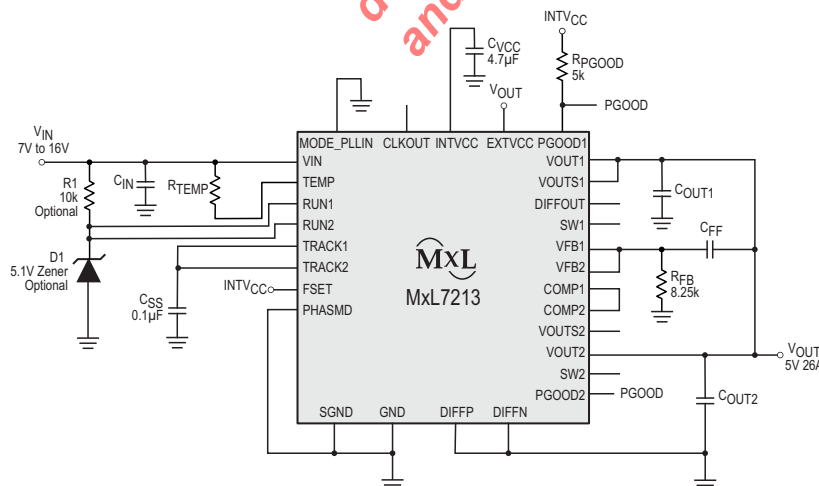

Figure 1: Typical Application: 26A, 5V Output DC/DC Power Module

Ordering Information - page 34

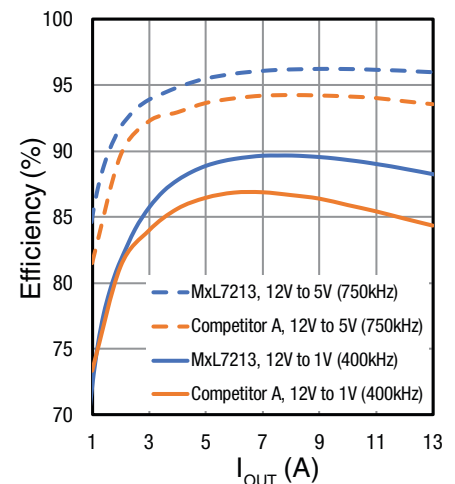

Figure 2: Efficiency Advantage vs. Competition

Revision History

Document No.	Release Date	Change Description
074DSR01	4/1/19	Initial release.
074DSR02	5/16/19	Remove stray line from Recommended PCB Layout. Correct number of phases sentence under Multiphase Operation and current source and external lock sentences under Frequency Selection and Phase-Lock Loop. Correct SGND to GND in INTVCC pin description. Changed TC_{VTEMP} to $-2.2\text{mV}/^\circ\text{C}$.
074DSR03	9/19/19	Update efficiency, power loss, and de-rating graphs. Removed output voltage noise graph. Update compensation section, thermal resistances, and capacitor table. V_{OUT} maximum changed to 16V. Update ordering information.

The product (or products) mentioned in this data sheet are no longer being manufactured and may not be ordered (OBS)

Table of Contents

General Description	i
Features	i
Applications	i
Specifications	1
Absolute Maximum Ratings.....	1
ESD Ratings.....	1
Operating Conditions.....	2
Electrical Characteristics	3
Pin Information	6
Pin Configuration.....	6
Pin Description	6
Typical Performance Characteristics	9
Functional Block Diagram	13
Operation	14
Power Module Description	14
Applications Information	14
Typical Application Circuit	14
V_{IN} to V_{OUT} Step-Down Ratios.....	14
Output Voltage Programming.....	15
Input Capacitors	15
Output Capacitors	16
Pulse-Skipping Mode Operation.....	16
Forced Continuous Operation	16
Multiphase Operation	16
Input RMS Ripple Current Cancellation.....	18
Frequency Selection and Phase-Lock Loop.....	18
Minimum On-Time.....	19
Soft Start and Output Voltage Tracking.....	19
Power Good	20
Stability and Compensation.....	21
Additional Compensation Information	21
Enabling the Channels	21
INTV _{CC} and EXTV _{CC}	22
Differential Remote Sense Amplifier.....	22

SW Pins.....	22
Temperature Monitoring (TEMP).....	22
Fault Protection	23
Thermal Considerations and Output Current Derating.....	23
Power Derating.....	24
Layout Guidelines and Example.....	28
Mechanical Dimensions	29
15mm x 15mm x 4.41mm LGA.....	29
Recommended Land Pattern and Stencil.....	30
15mm x 15mm x 4.41mm LGA.....	30
Mechanical Dimensions	31
15mm x 15mm x 5.01mm BGA	31
Recommended Land Pattern and Stencil.....	32
15mm x 15mm x 5.01mm BGA	32
MxL7213 Component Pinout	33
Ordering Information.....	34

The product (or products) mentioned in this data sheet are no longer being manufactured and may not be ordered (OBS)

List of Figures

Figure 1: Typical Application: 26A, 5V Output DC/DC Power Module.....	i
Figure 2: Efficiency Advantage vs. Competition	i
Figure 3: Pin Configuration	6
Figure 4: Efficiency: Single Phase, $V_{IN} = 5V$	9
Figure 5: Efficiency: Single Phase, $V_{IN} = 12V$	9
Figure 6: Efficiency: Dual Phase, $V_{IN} = 12V$	9
Figure 7: Output Current Sharing	9
Figure 8: 12V to 1V Load Step Response	10
Figure 9: 12V to 1.2V Load Step Response	10
Figure 10: 12V to 1.5V Load Step Response	10
Figure 11: 12V to 1.8V Load Step Response	10
Figure 12: 12V to 2.5V Load Step Response	11
Figure 13: 12V to 3.3V Load Step Response	11
Figure 14: 12V to 5V Load Step Response	11
Figure 15: Single Phase Start-Up, 12V to 1.5V, No Load.....	12
Figure 16: Single Phase Start-Up, 12V to 1.5V, 13A Load.....	12
Figure 17: Short-Circuit, 12V to 1.5V, 0A Load.....	12
Figure 18: Short-Circuit, 12V to 1.5V, 13A Load	12
Figure 19: Functional Block Diagram.....	13
Figure 20: Typical $5V_{IN}$ to $16V_{IN}$, 1.5V and 1.2V Outputs	15
Figure 21: 4-Phase Parallel Configuration.....	16
Figure 22: Examples of 2-Phase, 4-Phase and 6-Phase Operation with PHASMD Table	17
Figure 23: Normalized Input RMS Ripple Current vs. Duty Cycle, One to Six Phases	18
Figure 24: Operating Frequency vs. FSET Pin Voltage.....	18
Figure 25: V_{OUT} and V_{TRACK} versus Time	19
Figure 26: Example of Output Tracking Application Circuit	20
Figure 27: Output Coincident Tracking Waveform.....	20
Figure 28: C_{FF} Phase Boost vs. Frequency F_{zero} Normalized to 1	21
Figure 29: Diode Voltage vs. Temperature.....	22
Figure 30: 2-Phase, 5V at 26A with Temperature Monitoring.....	22
Figure 31: Graphical Representation of Thermal Coefficients.....	24
Figure 32: Power Loss, $V_{OUT} = 1.0V$	25
Figure 33: Current Derating, $V_{IN} = 5V$, $V_{OUT} = 1.0V$	25

Figure 34: Current Derating, $V_{IN} = 12V$, $V_{OUT} = 1.0V$	25
Figure 35: Power Loss, $V_{OUT} = 2.5V$	25
Figure 36: Current Derating, $V_{IN} = 5V$, $V_{OUT} = 2.5V$	25
Figure 37: Current Derating, $V_{IN} = 12V$, $V_{OUT} = 2.5V$	25
Figure 38: Power Loss, $V_{OUT} = 5V$	26
Figure 39: Current Derating, $V_{IN} = 12V$, $V_{OUT} = 5V$	26
Figure 40: Recommended PCB Layout	28
Figure 41: Mechanical Dimensions, LGA	29
Figure 42: Recommended Land Pattern and Stencil, LGA	30
Figure 43: Mechanical Dimensions, BGA	31
Figure 44: Recommended Land Pattern and Stencil, BGA	32

**The product (or products) mentioned in this
data sheet are no longer being manufactured
and may not be ordered (OBS)**

List of Tables

Table 1: Absolute Maximum Ratings	1
Table 2: ESD Ratings	1
Table 3: Operating Conditions	2
Table 4: Electrical Characteristics	3
Table 5: Pin Description.....	6
Table 6: VFB Resistor Table vs. Various Output Voltages	15
Table 7: Θ_{JA} and Derating Curves Corresponding to 1.0V Output.....	24
Table 8: Θ_{JA} and Derating Curves Corresponding to 2.5V Output.....	24
Table 9: Θ_{JA} and Derating Curves Corresponding to 5V Output.....	24
Table 10: Capacitors Used for Output Voltage Response Matrix	27
Table 11: Output Voltage Response vs. Component Matrix.....	27
Table 12: MxL7213 Component Pinout	33
Table 13: Ordering Information.....	34

The product (or products) mentioned in this data sheet are no longer being manufactured and may not be ordered (OBS)

Specifications

Absolute Maximum Ratings

Important: The stresses above what is listed under Table 1 may cause permanent damage to the device. This is a stress rating only—functional operation of the device above what is listed under Table 1 or any other conditions beyond what MaxLinear recommends is not implied. Exposure to conditions above what is listed under Table 3 for extended periods of time may affect device reliability. Solder reflow profile is specified in the IPC/JEDEC J-STD-020C standard.

Table 1: Absolute Maximum Ratings

Parameter	Minimum	Maximum	Units
V_{IN}	-0.3	18	V
V_{SW1}, V_{SW2}	-1	23	V
PGOOD1, PGOOD2, COMP1, COMP2	-0.3	6	V
INTV _{CC} , EXTV _{CC}	-0.3	6	V
MODE/PLLIN, f _{SET} , TRACK1, TRACK2	-0.3	INTV _{CC}	V
DIFFOUT	-0.3	INTV _{CC} - 1.1V	V
PHASMD	-0.3	INTV _{CC}	V
$V_{OUT1}, V_{OUT2}, V_{OUTS1}, V_{OUTS2}$	-0.3	6	V
DIFFP, DIFFN	-0.3	INTV _{CC}	V
RUN1, RUN2, V _{FB1} , V _{FB2}	-0.3	INTV _{CC}	V
INTV _{CC} Peak Output Current		100	mA
Storage Temperature Range	-65	150	°C
Peak Package Body Temperature		245	°C

ESD Ratings

Table 2: ESD Ratings

Parameter	Minimum	Maximum	Units
HBM (Human Body Model)		2k	V
CDM (Charged Device Model)		500	V

Operating Conditions

Table 3: Operating Conditions

Parameter	Minimum	Typical	Maximum	Units
V_{IN}	4.5		16	V
$INTV_{CC}$	4.5		5.5	V
$EXTV_{CC}$	4.7		6	V
PGOOD	0		$INTV_{CC}$	V
Switching Frequency	250		780	kHz
Junction Temperature Range (T_J)	-40		125	°C
Thermal Resistance from Junction to Ambient (Θ_{JA})		7		°C/W
Thermal Resistance from Junction to Bottom of Module Case ($\Theta_{JCbottm}$)		1.5		°C/W
Thermal Resistance from Junction to Top of Module Case (Θ_{Jctop})		3.86		°C/W

The product (or products) mentioned in this data sheet are no longer being manufactured and may not be ordered (OBS)

Electrical Characteristics

Specifications are for Operating Junction Temperature of $T_J = 25^\circ\text{C}$ only; limits applying over the full Operating Junction Temperature range are denoted by a ". Typical values represent the most likely parametric norm at $T_J = 25^\circ\text{C}$ and are provided for reference purposes only. Unless otherwise indicated, $V_{IN} = 12\text{V}$ and $V_{RUN1}, V_{RUN2} = 5\text{V}$. Per [Figure 20](#).

Table 4: Electrical Characteristics

Symbol	Parameter	Conditions	•	Min	Typ	Max	Units
DC Specifications							
$V_{IN(DC)}$	Input DC voltage		•	4.5		16	V
$V_{OUT1(RANGE)}$ $V_{OUT2(RANGE)}$	Output DC range	$V_{IN} = 5.5\text{V to }16.0\text{V}$	•	0.6		5.3	V
$V_{OUT1(DC)}$ $V_{OUT2(DC)}$	V_{OUT} total variation with line and load	$C_{IN} = 22\ \mu\text{F} \times 3$ $C_{OUT} = 100\ \mu\text{F} \times 1$ Ceramic, 220 μF POSCAP, MODE_PLLIN = GND $V_{IN} = 12\text{V}, V_{OUT} = 1.5\text{V}$	•	1.477	1.5	1.523	V
Input Specifications							
V_{RUN1}, V_{RUN2}	RUN pin on/off threshold	RUN rising		1.1	1.25	1.40	V
$V_{RUN1HYS}, V_{RUN2HYS}$	RUN pin ON hysteresis				170		mV
$I_{INRUSH(VIN)}$	Input inrush current at start-up	$I_{OUT} = 0\text{A}, C_{IN} = 3 \times 22\ \mu\text{F}, C_{SS} = 0.01\ \mu\text{F},$ $C_{OUT} = 3 \times 100\ \mu\text{F}, V_{OUT1} = 1.5\text{V},$ $V_{OUT2} = 1.5\text{V}, V_{IN} = 12\text{V}$			0.5		A
$I_{Q(VIN)}$	Input supply bias current	$V_{IN} = 12\text{V}, V_{OUT} = 1.5\text{V},$ pulse-skipping mode			5		mA
		$V_{IN} = 12\text{V}, V_{OUT} = 1.5\text{V},$ switching CCM			85		
		Shutdown, RUN = 0, $V_{IN} = 12\text{V}$			50		μA
$I_{S(VIN)}$	Input supply current	$V_{IN} = 5\text{V}, V_{OUT} = 1.5\text{V}, I_{OUT} = 13\text{A}$			4.34		A
		$V_{IN} = 12\text{V}, V_{OUT} = 1.5\text{V}, I_{OUT} = 13\text{A}$			1.82		
Output Specifications							
$I_{OUT1(DC)}, I_{OUT2(DC)}$	Output continuous current range ⁽¹⁾	$V_{IN} = 12\text{V}, V_{OUT} = 1.5\text{V}$		0		13	A
$\Delta V_{OUT1(LINE)}/V_{OUT1}$ $\Delta V_{OUT2(LINE)}/V_{OUT2}$	Line regulation accuracy	$V_{OUT} = 1.5\text{V}, V_{IN}$ from 4.75V to 16V $I_{OUT} = 0\text{A}$ for each output	•		0.016	0.025	%/V
$\Delta V_{OUT1(LOAD)}/V_{OUT1}$ $\Delta V_{OUT2(LOAD)}/V_{OUT2}$	Load regulation accuracy ⁽¹⁾	$V_{OUT} = 1.5\text{V}, 0\text{A to }13\text{A}, V_{IN} = 12\text{V}$	•		0.35	0.5	$\pm\%$
$V_{OUT1(AC)}, V_{OUT2(AC)}$	Output ripple voltage	For each output; $I_{OUT} = 0\text{A},$ $C_{OUT} = 100\ \mu\text{F} \times 3 / \text{X7R} / \text{ceramic},$ 470 μF POSCAP, $V_{IN} = 12\text{V}, V_{OUT} = 1.5\text{V},$ frequency = 400kHz			26		mV _{PP}
f_S (each channel)	Output ripple voltage frequency ⁽²⁾	$V_{IN} = 12\text{V}, V_{OUT} = 1.5\text{V}, f_{SET} = 1.25\text{V}$			500		kHz
f_{SYNC} (each channel)	SYNC capture range			400		780	kHz

Table 4: (Continued) Electrical Characteristics

Symbol	Parameter	Conditions	•	Min	Typ	Max	Units
$\Delta V_{OUT1START}$ $\Delta V_{OUT2START}$	Turn-on overshoot	$C_{OUT} = 100\mu F / X5R / \text{ceramic}, 470\mu F$ POSCAP, $V_{OUT} = 1.5V$, $I_{OUT} = 0A$, $V_{IN} = 12V$ Each channel			10		mV
t_{START1} , t_{START2}	Turn-on time	$C_{OUT} = 100\mu F / X5R / \text{ceramic},$ 470 μF POSCAP, No load, TRACK/SS with 0.01 μF to GND, $V_{IN} = 12V$ Each channel			4.8		ms
$\Delta V_{OUT1(LS)}$ $\Delta V_{OUT2(LS)}$	Peak deviation for dynamic load	Load: 0% to 50% to 0% of full load $C_{OUT} = 22\mu F \times 3 / X5R / \text{ceramic},$ 470 μF POSCAP, $V_{IN} = 12V$, $V_{OUT} = 1.5V$ Each channel			30		mV
$t_{SETTLE1}$, $t_{SETTLE2}$	Settling time for dynamic load step	Load: 0% to 50% to 0% of full load, $V_{IN} = 12V$, $C_{OUT} = 100\mu F, 470\mu F$ POSCAP Each channel			20		μs
$I_{OUT1(PK)}$ $I_{OUT2(PK)}$	Output current limit	$V_{IN} = 12V$, $V_{OUT} = 1.5V$ Each channel			20		A
Control Section							
V_{FB1} , V_{FB2}	Voltage at V_{FB} pins	$I_{OUT} = 0A$, $V_{OUT} = 1.5V$	•	0.594	0.600	0.606	V
I_{FB}	Current at V_{FB} pins				-5	-20	nA
V_{OVL}	Feedback overvoltage lockout		•	0.64	0.66	0.68	V
TRACK1 (I), TRACK2 (I)	Track pin soft-start pull-up current	TRACK1 (I), TRACK2 (I) start at 0V		1.1	1.25	1.4	μA
UVLO	Undervoltage lockout	V_{IN} falling V_{IN} rising			3.66		V
					4.25		V
UVLO Hysteresis					600		mV
$t_{ON(MIN)}$	Minimum on-time				90		ns
R_{FBHI1} , R_{FBHI2}	Resistor between V_{OUTS1} , V_{OUTS2} and V_{FB1} , V_{FB2}	Each output		60.05	60.4	60.75	k Ω
$V_{PGOOD1 LOW}$, $V_{PGOOD2 LOW}$	PGOOD voltage low	$I_{PGOOD} = 2mA$			35	50	mV
I_{PGOOD}	PGOOD leakage current	$V_{PGOOD} = 5V$				± 5	μA
V_{PGOOD}	PGOOD trip level	V_{FB} with respect to set output voltage V_{FB} ramping negative			-10		%
		V_{FB} with respect to set output voltage V_{FB} ramping positive			10		
INTV_{CC} Linear Regulator							
V_{INTVCC}	Internal V_{CC} voltage	$6V < V_{IN} < 16V$		4.8	5	5.2	V
V_{INTVCC} Load Regulation	INTV _{CC} load regulation	$I_{CC} = 0mA$ to 50mA			1	2	%

Table 4: (Continued) Electrical Characteristics

Symbol	Parameter	Conditions	•	Min	Typ	Max	Units
V_{EXTVCC}	EXTV _{CC} switchover voltage	EXTV _{CC} ramping positive	•	4.5	4.7		V
$V_{EXTVCC(DROP)}$	EXTV _{CC} dropout	$I_{CC} = 20\text{mA}$, $V_{EXTVCC} = 5\text{V}$			19	50	mV
$V_{EXTVCC(HYST)}$	EXTV _{CC} hysteresis				156		mV
Oscillator and Phase-Locked Loop							
Frequency Nominal	Nominal frequency	FSET = 1.2V		450	500	550	kHz
Frequency Low	Lowest frequency	FSET = 0V		210	250	290	kHz
Frequency High	Highest frequency	FSET > 2.4V, up to INTV _{CC}		700	780	860	kHz
I_{FSET}	Frequency set current			9	10	11	μA
f_{SYNC}	SYNC capture range	Each channel		250		780	kHz
R_{MODE_PLLIN}	MODE_PLLIN input resistance				250		kΩ
CLKOUT	Phase (relative to V _{OUT1})	PHASMD = GND			60		Deg
		PHASMD = float			90		Deg
		PHASMD = INTV _{CC}			120		Deg
CLK High	Clock High output voltage			2		V	
CLK Low	Clock Low output voltage					0.2	V
Differential Amplifier							
A_V	Gain				1		V/V
R_{IN}	Input resistance	Measured at DIFFP Input			80		kΩ
V_{OS}	Input offset voltage	$V_{DIFFP} = V_{DIFFOUT} = 1.5\text{V}$, $I_{DIFFOUT} = 100\mu\text{A}$				2	mV
PSRR	Power Supply Rejection Ratio	$5\text{V} \leq V_{IN} \leq 16\text{V}$			90		dB
I_{CL}	Maximum Output current				3		mA
$V_{DIFFOUT(MAX)}$	Maximum output voltage	$I_{DIFFOUT} = 300\mu\text{A}$		INTV _{CC} - 1.4			V
GBW	Gain Bandwidth Product				3		MHz
V_{TEMP}	Diode Connected PNP	$I = 100\mu\text{A}$			0.636		V
TC_{VTEMP}	Temperature Coefficient		•		-2.2		mV/°C
OT	Thermal shutdown threshold	Rising temperature			145		°C
	Thermal hysteresis				15		°C

1. See output current derating curves for different V_{IN} , V_{OUT} and T_A .
2. The switching frequency is programmable from 250kHz to 780kHz.

Pin Information

Pin Configuration

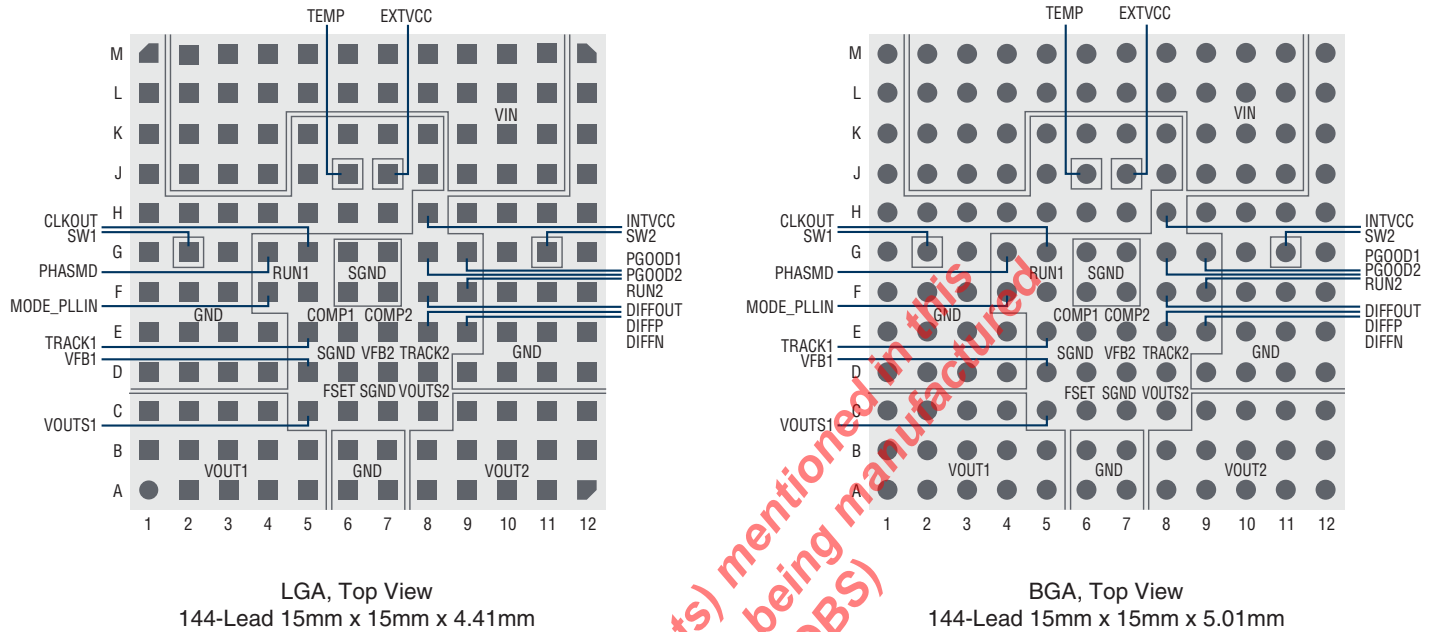

Figure 3: Pin Configuration

Pin Description

Table 5: Pin Description

Pin Number	Pin Name	Description
A1, A2, A3, A4, A5, B1, B2, B3, B4, B5, C1, C2, C3, C4	VOUT1	Output of the channel 1 power stage. Connect the corresponding output load from the VOUT1 pins to the PGND pins. Direct output decoupling capacitance from VOUT1 to PGND is recommended.
A6, A7, B6, B7, D1, D2, D3, D4, D9, D10, D11, D12, E1, E2, E3, E4, E10, E11, E12, F1, F2, F3, F10, F11, F12, G1, G3, G10, G12, H1, H2, H3, H4, H5, H6, H7, H9, H10, H11, H12, J1, J5, J8, J12, K1, K5, K6, K7, K8, K12, L1, L12, M1, M12	GND	Ground for the power stage. Connect to the application's power ground plane.
A8, A9, A10, A11, A12, B8, B9, B10, B11, B12, C9, C10, C11, C12	VOUT2	Output of the channel 2 power stage. Connect the corresponding output load from the VOUT2 pins to the PGND pins. Direct output decoupling capacitance from VOUT2 to PGND is recommended.

Table 5: Pin Description (Continued)

Pin Number	Pin Name	Description
C5, C8	VOUTS1, VOUTS2	These pins are connected internally to the top of the feedback resistor for each output. Connect this pin directly to its specific output or to DIFFOUT when using the remote sense amplifier. When paralleling modules, connect one of the VOUTS pins to DIFFOUT when remote sensing or directly to VOUT when not remote sensing. These pins must be connected to either DIFFOUT or VOUT. This connection provides the feedback path and cannot be left open.
C6	FSET	This pin is used to set the operating frequency via two methods: <ul style="list-style-type: none"> Connect a resistor from this pin to ground Drive this pin with a DC voltage This pin sources a 10 μ A current. See Figure 24 for frequency of operation vs. FSET voltage.
C7, D6, G6, G7, F6, F7	SGND	Ground pin for all analog signals and low power circuits. Connect to GND in one place. See layout guidelines in Figure 40 .
D5, D7	VFB1, VFB2	Feedback input to the negative side of the error amplifier for each channel. These pins are each internally connected to VOUTS1 and VOUTS2 via a precision 60.4k Ω resistor. Vary each output voltage by adding a feedback resistor from VFB to SGND. Tie VFB1 and VFB2 together for parallel operation.
E5, D8	TRACK1, TRACK2	Soft-Start and Output Voltage Tracking pins. Each channel has a 1.25 μ A pull-up current source. When one channel is configured as a master, adding a capacitor from this pin to ground sets a soft-start ramp rate. The other channel can be set up as the slave and have the master output applied through a voltage divider to the slave's output TRACK pin. For coincidental tracking, this voltage divider is equal to the slave's output feedback divider.
E6, E7	COMP1, COMP2	Current control threshold and error amplifier compensation point for each channel. The current comparator threshold increases with this control voltage. The MxL7213 is internally compensated, however a feed-forward C _{FF} is frequently required (see Table 11). R _{COMP} and C _{COMP} may be required for certain operating conditions (see Figure 20). When paralleling both channels, connect the COMP1 and COMP2 pins together.
E8	DIFFP	This pin is the remote sense amplifier's positive input and is connected to the output voltage's remote sense point. If the remote sense amplifier is not used, connect this pin to SGND. Important: The differential amplifier cannot be used for outputs > 3.3V.
E9	DIFFN	This pin is the remote sense amplifier's negative input and is connected to the remote sense point GND. If the remote sense amplifier is not used, connect this pin to SGND. Important: The differential amplifier cannot be used for outputs >3.3V.
F4	MODE_PLLIN	Selects between Forced Continuous Mode or Pulse-Skipping Mode and provides the external synchronization input to the Phase Detector Pin. There are three connection options: <ol style="list-style-type: none"> Connect this pin to SGND to force both channels into Forced Continuous Mode. Connect this pin to INTVCC or leave it floating to enable Pulse-Skipping Mode. Connect this pin to an external clock to force both channels into Forced Continuous Mode that are synchronized to the external clock.
F5, F9	RUN1, RUN2	The RUN1 and RUN2 pins enable and disable the module's two channels: <ul style="list-style-type: none"> A voltage above 1.4V will turn on the related channel. A voltage below 1.1V will turn off the related channel. Each RUN pin has a 1 μ A pull-up current; once the RUN pin reaches ~1.25V, an additional 4.5 μ A pull-up current is added to the RUN pin.
F8	DIFFOUT	Output of the internal remote sense amplifier. If remote sensing on channel 1, connect to VOUTS1. If remote sensing on channel 2, connect to VOUTS2. When paralleling modules, connect one of the VOUTS pins to DIFFOUT when remote sensing. Important: The differential amplifier cannot be used for outputs >3.3V.

Table 5: Pin Description (Continued)

Pin Number	Pin Name	Description
G2, G11	SW1, SW2	Use these pins to access the switching node of each channel. An RC snubber can be connected to reduce switch node ringing. Otherwise, leave these pins floating.
G4	PHASMD	This pin selects the CLKOUT phase as follows: <ul style="list-style-type: none"> ■ Connect to SGND for 60 degrees ■ Connect to INTVCC for 120 degrees ■ Leave floating for 90 degrees
G5	CLKOUT	This is the clock output. Its phase is set with the PHASMD pin. It is also used during Multiphase Operation. Refer to the Application Section on Multiphase Operation for more details.
G9, G8	PGOOD1, PGOOD2	Power Good outputs. This open-drain output is pulled low when the V_{OUT} of its respective channel is more than $\pm 10\%$ outside regulation.
H8	INTVCC	Internal 5V Regulator Output. This voltage powers the control circuits and internal gate driver. Decouple to GND with a 4.7 μ F ceramic capacitor. INTVCC is activated when either RUN1 or RUN2 is activated.
J6	TEMP	The internal temperature sensing diode monitors the temperature change with voltage change on V_{BE} . Connect to VIN through a resistor to limit the current to 100 μ A. $R = (V_{IN} - 0.6V) / 100\mu A$
J7	EXTVCC	External power input that is enabled through a switch to INTVCC whenever EXTVCC is >4.7V. Do not exceed 6V on this input. Connect this pin to V_{IN} when operating V_{IN} on 5V. An efficiency increase that is a function of $(V_{IN} - INTV_{CC})$ multiplied by the power MOSFET driver current occurs when the feature is used. V_{IN} must be applied before EXTVCC, and EXTVCC must be removed before V_{IN} . To increase efficiency, a 5V output can be tied to this pin.
M2, M3, M4, M5, M6, M7, M8, M9, M10, M11, L2, L3, L4, L5, L6, L7, L8, L9, L10, L11, J2, J3, J4, J9, J10, J11, K2, K3, K4, K9, K10, K11	VIN	Power input pins. Connect input voltage from these pins to GND. Direct input decoupling capacitance from VIN to GND is recommended.

1. Use test points to monitor signal pin connections.

Typical Performance Characteristics

See Figure 20 for typical application schematic.

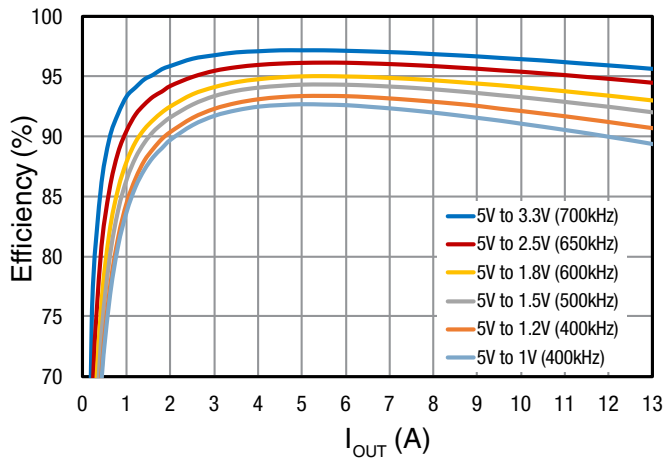

Figure 4: Efficiency: Single Phase, $V_{IN} = 5V$

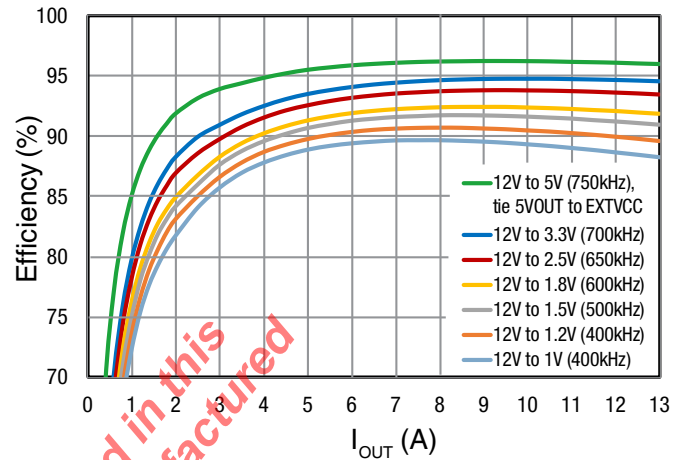

Figure 5: Efficiency: Single Phase, $V_{IN} = 12V$

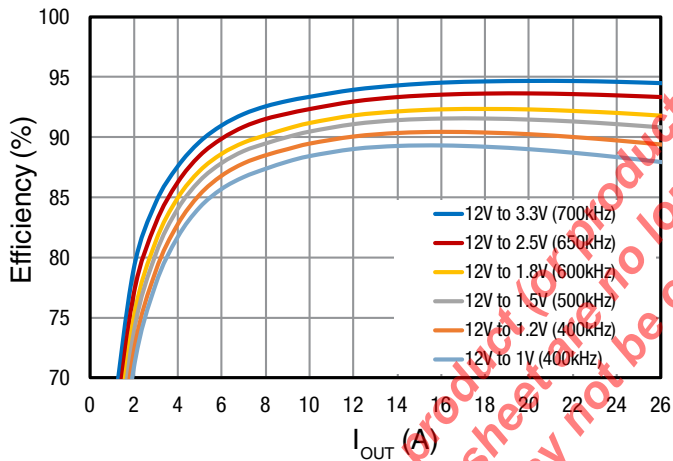
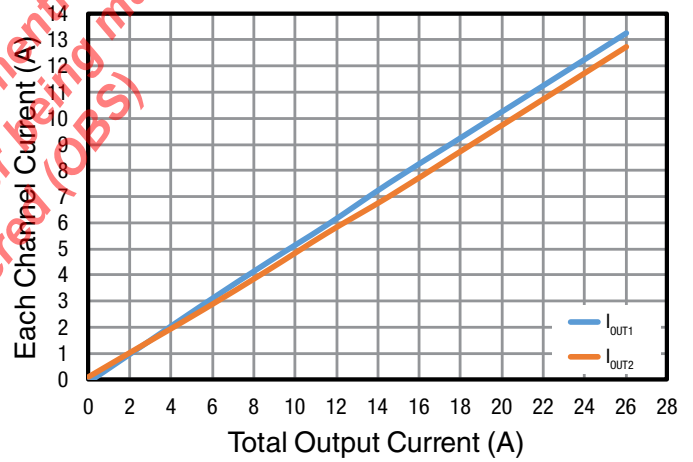

Figure 6: Efficiency: Dual Phase, $V_{IN} = 12V$



$12V_{IN}, 1.5V_{OUT},$
 $C_{OUT} = 2 \times 470\mu F / 10m\Omega$ each POSCAP, $100\mu F$ ceramic

Figure 7: Output Current Sharing

See Figure 20 for typical application schematic.

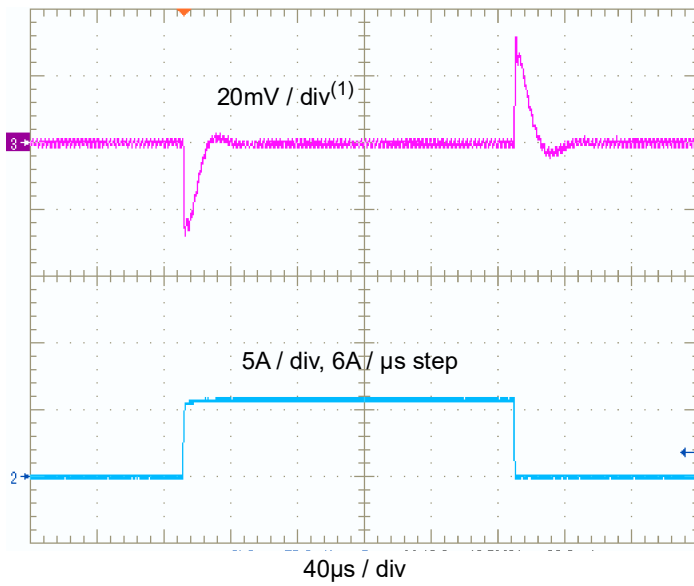

C_{OUT} : 2 x 470 μ F / 10m Ω each POSCAP, 100 μ F ceramic;
 C_{FF} = 180pF

Figure 8: 12V to 1V Load Step Response

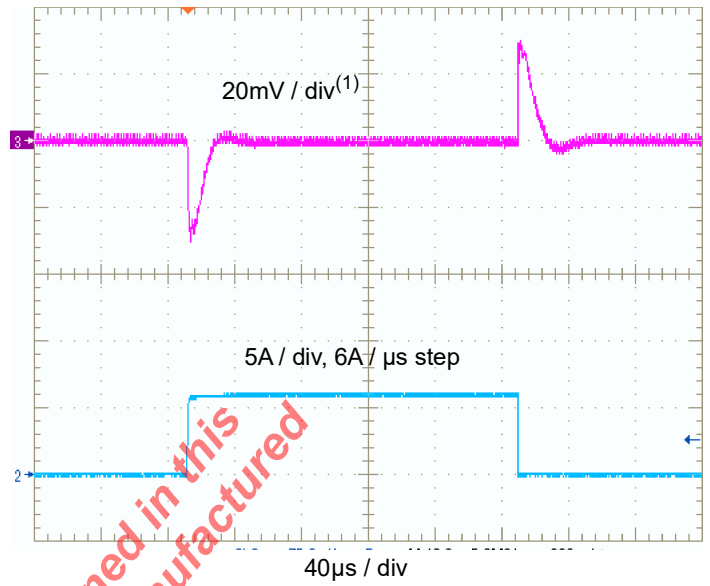

C_{OUT} : 2 x 470 μ F / 10m Ω each POSCAP, 100 μ F ceramic;
 C_{FF} = 180pF

Figure 9: 12V to 1.2V Load Step Response

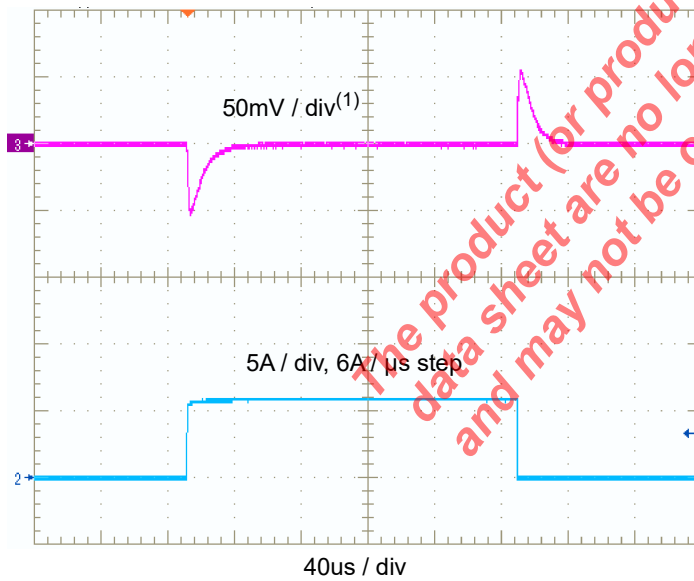

C_{OUT} : 220 μ F / 9m Ω POSCAP, 100 μ F ceramic; C_{FF} = 100pF,

Figure 10: 12V to 1.5V Load Step Response

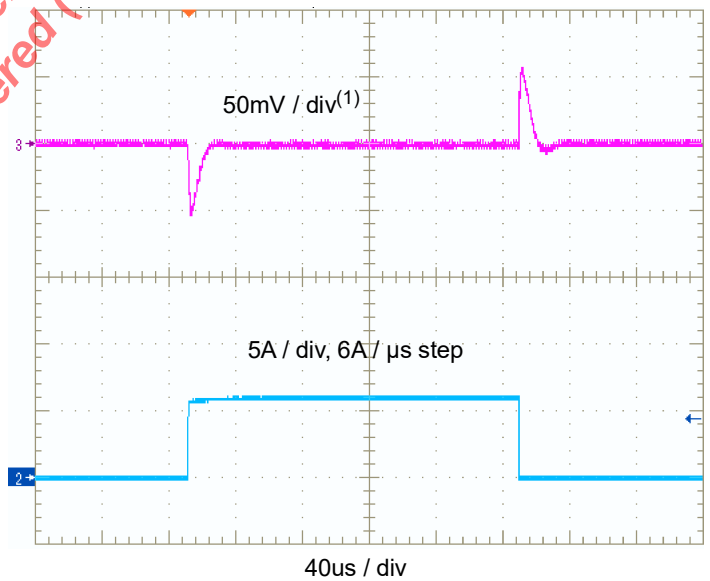

C_{OUT} : 220 μ F / 9m Ω POSCAP, 100 μ F ceramic; C_{FF} = 47pF

Figure 11: 12V to 1.8V Load Step Response

1. Waveform averaged to remove high frequency ripple.

See Figure 20 for typical application schematic.

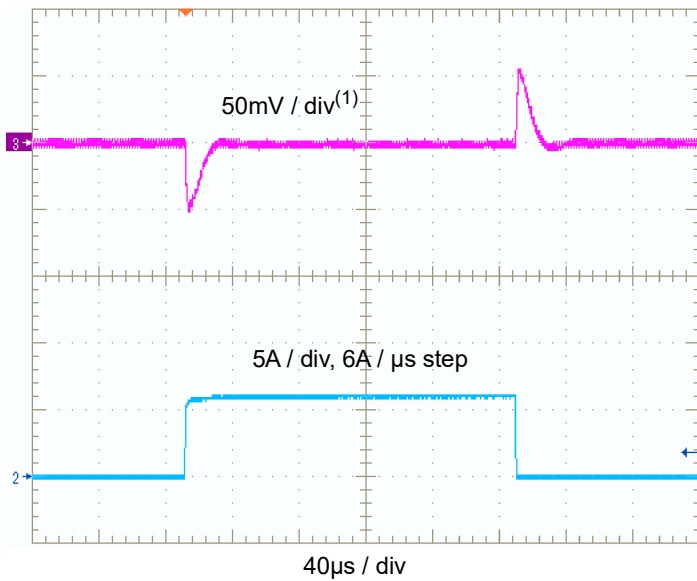

C_{OUT}: 220µF / 9mΩ POSCAP, 100µF ceramic

Figure 12: 12V to 2.5V Load Step Response

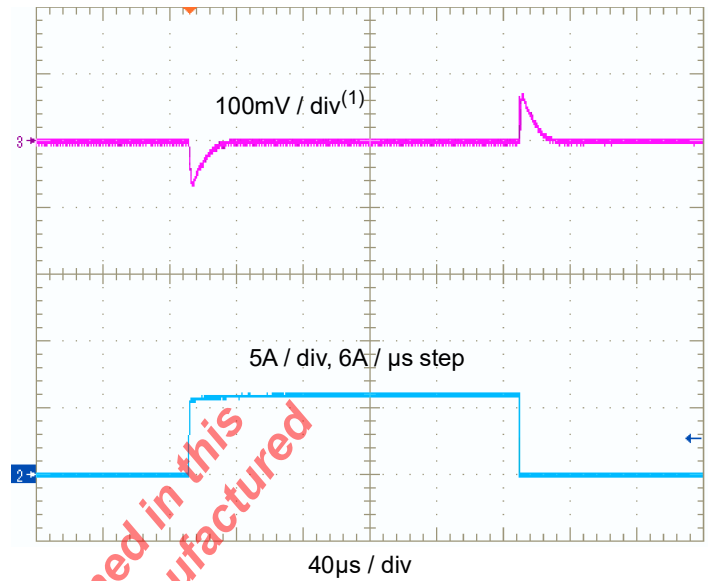

C_{OUT}: 100µF / 18mΩ POSCAP, 100µF ceramic; C_{FF} = 47pF

Figure 13: 12V to 3.3V Load Step Response

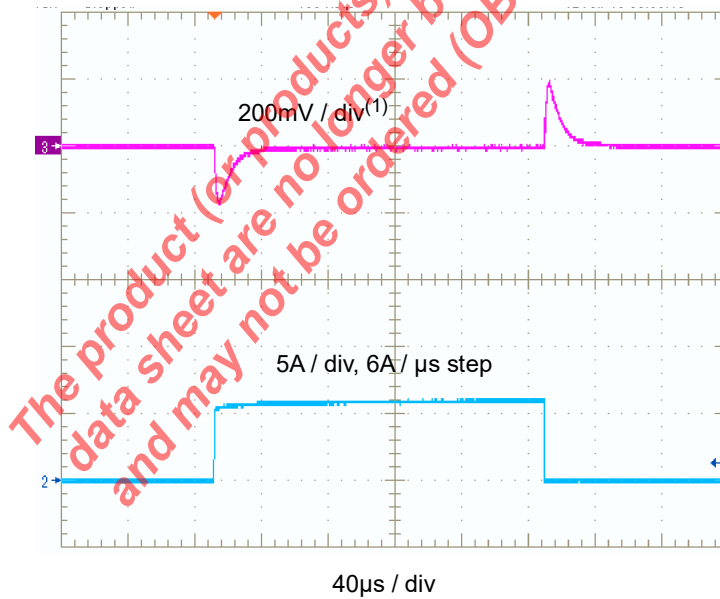

C_{OUT}: 100µF ceramic; C_{FF} = 22pF

Figure 14: 12V to 5V Load Step Response

1. Waveform averaged to remove high frequency ripple.

See Figure 20 for typical application schematic.

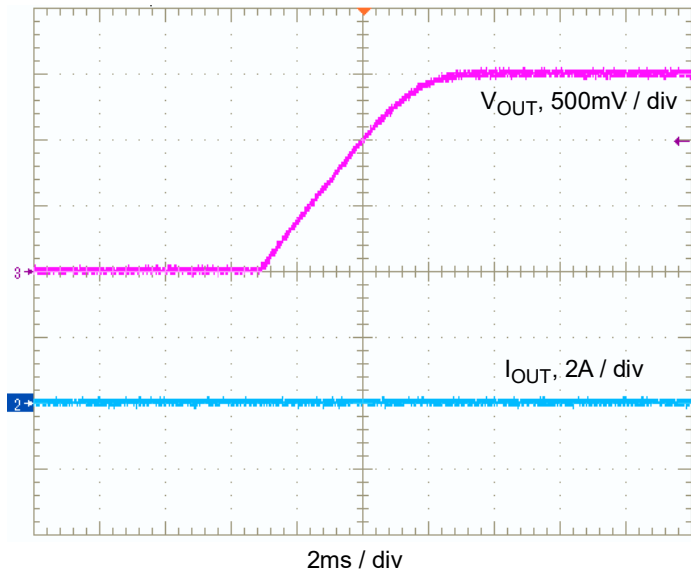

12V_{IN}, 1.5V_{OUT}, soft-start capacitor = 0.01μF,
C_{OUT} = 2 x 470μF / 10mΩ each POSCAP, 100μF ceramic,
use RUN pin to control start-up

**Figure 15: Single Phase Start-Up,
12V to 1.5V, No Load**

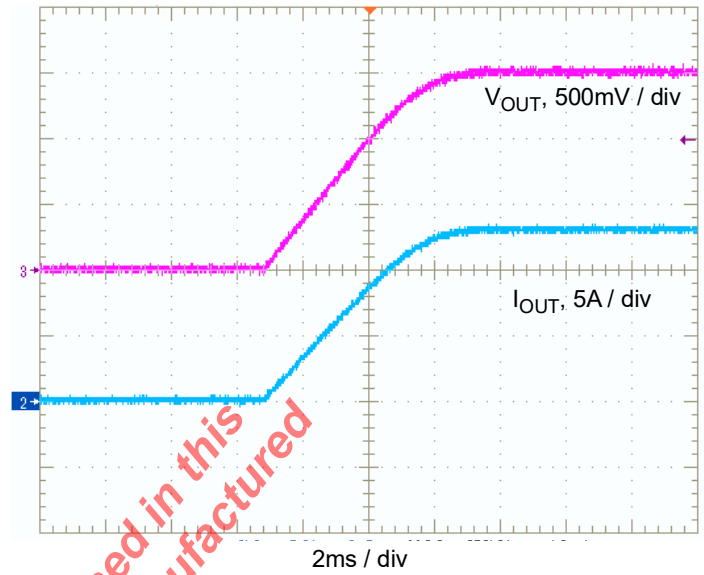

12V_{IN}, 1.5V_{OUT}, soft-start capacitor = 0.01μF,
C_{OUT} = 2 x 470μF / 10mΩ each POSCAP, 100μF ceramic,
use RUN pin to control start-up

**Figure 16: Single Phase Start-Up,
12V to 1.5V, 13A Load**

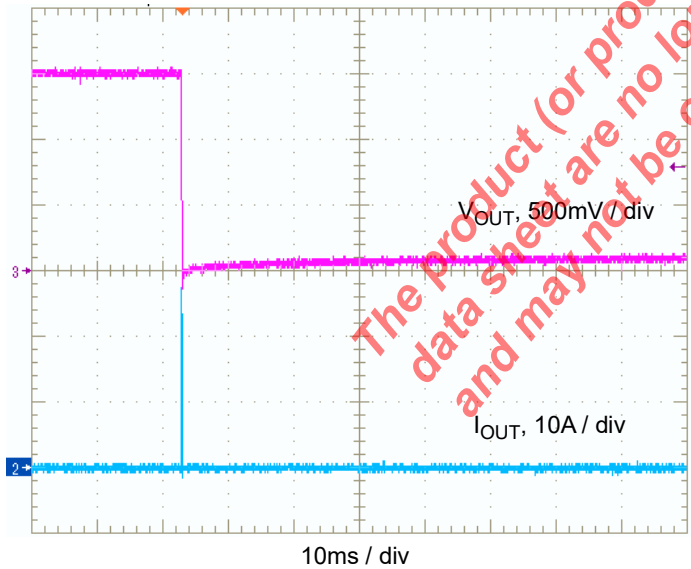

12V_{IN}, 1.5V_{OUT}, soft-start capacitor = 0.01μF,
C_{OUT} = 2 x 470μF / 10mΩ each POSCAP, 100μF ceramic

Figure 17: Short-Circuit, 12V to 1.5V, 0A Load

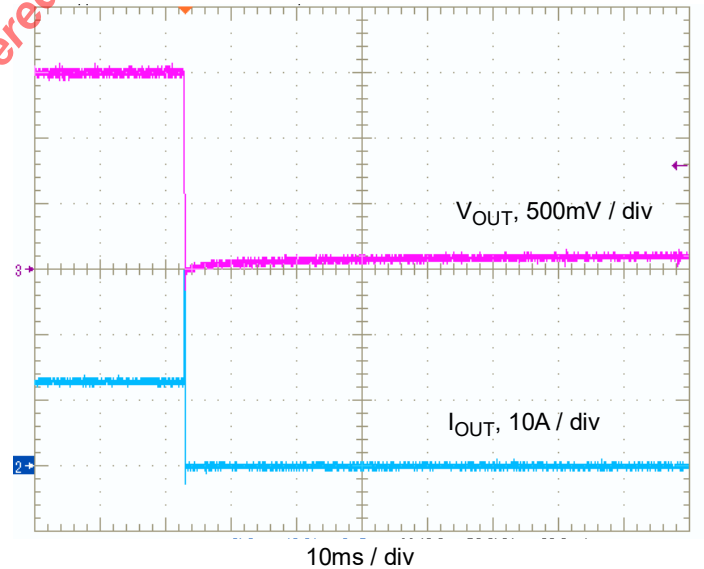

12V_{IN}, 1.5V_{OUT}, soft-start capacitor = 0.01μF,
C_{OUT} = 2 x 470μF / 10mΩ each POSCAP, 100μF ceramic

Figure 18: Short-Circuit, 12V to 1.5V, 13A Load

Functional Block Diagram

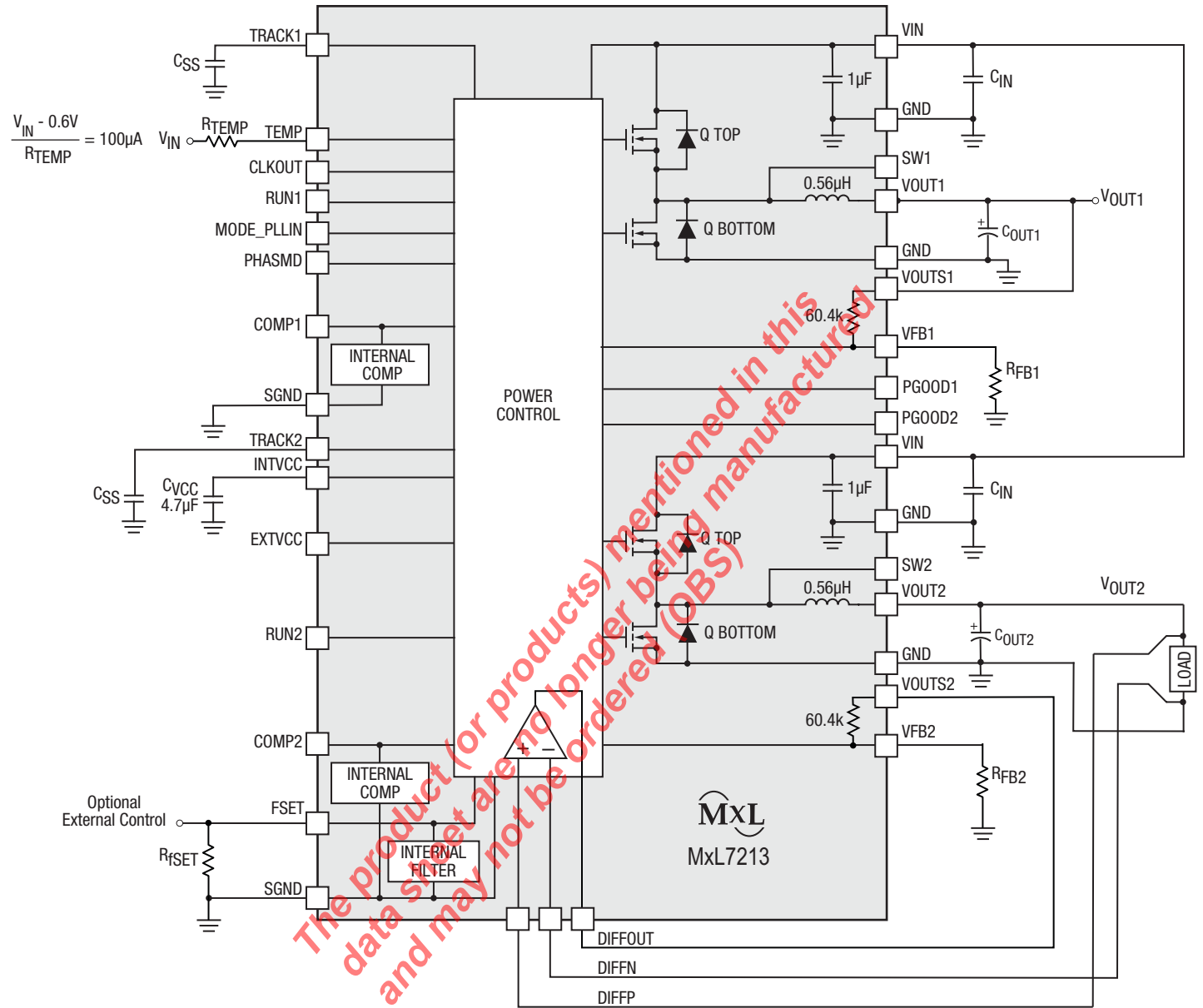

Figure 19: Functional Block Diagram

Operation

Power Module Description

The MxL7213 is a dual-channel, standalone, synchronous step-down power module that provides two 13A outputs or one 26A output. This power module has a continuous input voltage range of 4.5V to 16V and has been optimized for 12V conversions. It provides precisely regulated output voltages from 0.6V to 5.3V that are set by a single external resistor. See typical application schematic in [Figure 20](#).

The module employs a constant frequency, peak current mode control loop architecture. It also has an internal feedback loop compensation. These features ensure the MxL7213 has sufficient stability margins as well as good transient performance over a wide range of output capacitors, including low ESR ceramic capacitors.

The peak current mode control supports cycle-by-cycle fast current limit and current limit hiccup in overcurrent or output short circuit conditions. The open-drain PGOOD outputs are pulled low when the output voltage exceeds $\pm 10\%$ of its set point. Once the output voltage exceeds $+10\%$, the high side MOSFET is kept off while the low side MOSFET turns on, clamping the output voltage. The overvoltage and undervoltage detection are referenced to the feedback pin.

The RUN1 and RUN2 pins enable and disable the module's two channels. Pulling a RUN pin below 1.1V forces the respective regulator into shutdown mode and turns off both the high side and low side MOSFETs. The TRACK pins are used for either programming the output voltage ramp and voltage tracking during start-up, or for soft-starting the channels.

The MxL7213 includes a differential remote sense amplifier (with a gain of +1). This amplifier can be used to accurately sense the voltage at the load point on one of the module's two outputs or on a single parallel output.

The switching frequency is programmed from 250kHz to 780kHz using an external resistor on the FSET pin. For noise sensitive applications, the module can be synchronized to an external clock.

The MxL7213 module can be configured to current share between channels. It can also be set to current share between modules (multiphase or ganged operation). Using the MODE_PLLIN, PHASMD and CLKOUT pins, multiphase operation of up to 8 phases is possible with multiple MxL7213s running in parallel.

Using the the MODE_PLLIN pin to operate in pulse-skipping mode results in high efficiency performance at

light loads. This light load feature extends battery life.

The EXTVCC pin allows an external 5V supply to power the module and reduce the power dissipation in the internal 5V LDO. EXTVCC has a threshold of 4.7V for activation and a max rating of 6V. It must sequence on after V_{IN} and sequence off before V_{IN} .

Monitor the internal die temperature by using the TEMP pin. Pull the anode up to V_{IN} through an external resistor to set the bias current in the diode. Thermal simulation has shown that the thermal monitor on the controller die is within 5°C of the MOSFETs.

Applications Information

Typical Application Circuit

The typical MxL7213 application circuit is shown in [Figure 20](#). External component selection is primarily determined by the maximum load current and output voltage. Refer to [Table 11](#) for a selection of various design solutions. Additional information about selecting external compensation components can be found in the [Stability and Compensation](#) section.

V_{IN} to V_{OUT} Step-Down Ratios

For a given input voltage, there are limitations to the maximum possible V_{IN} and V_{OUT} stepdown ratios.

The MxL7213 has a maximum duty cycle of 90% at 500kHz, meaning the maximum output voltage will be approximately $0.9 \times V_{IN}$. When running at high duty cycle, output current can be limited by the power dissipation in the high-side MOSFET. The minimum output voltage from a given input is controlled by the minimum on-time which is 90ns. The minimum output voltage is $V_{IN} \times f_{SW}(\text{MHz}) \times 0.09\mu\text{s}$. To get a lower output voltage, reduce the switching frequency.

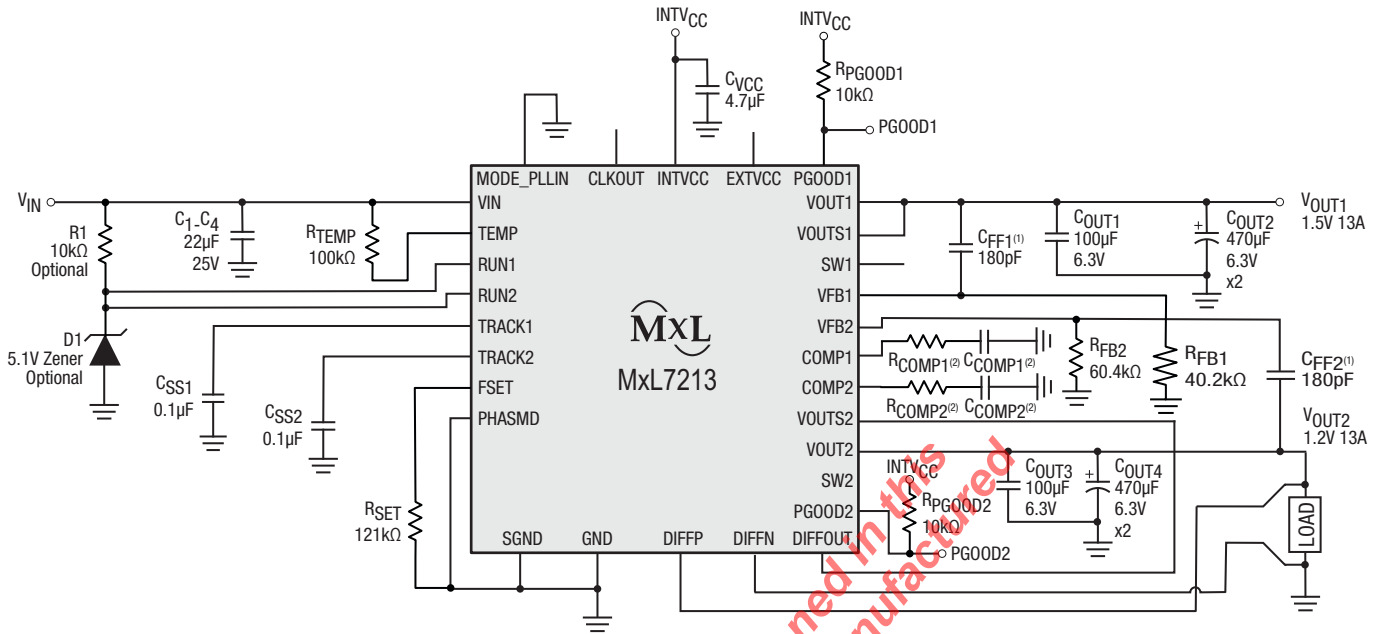

1. See Table 11.
2. May be necessary for certain operating conditions.

Figure 20: Typical 5V_{IN} to 16V_{IN}, 1.5V and 1.2V Outputs

Output Voltage Programming

The PWM controller has an internal 0.6V reference. A resistor R_{FB} between the VFB and SGND pins programs the output voltage. A 60.4kΩ internal feedback resistor is connected from VOUTS1 to VFB1 and from VOUTS2 to VFB2, as illustrated in the functional block diagram.

R_{FB} values for corresponding standard V_{OUT} values are shown in Table 6. Use the following equation to determine the R_{FB} value for other V_{OUT} levels:

$$V_{OUT} = \frac{0.6 \times (60.4 + R_{FB})}{R_{FB}}$$

When paralleling multiple channels and devices, a common R_{FB} resistor may be used. Select the R_{FB} as explained above. Note that VFB pins have an I_{FB} max of 20nA per channel. To reduce V_{OUT} error due to I_{FB}, use an additional R_{FB} and connect corresponding VOUTS to VOUT as shown in Figure 21.

When paralleling multiple channels and devices:

- Tie all COMP pins together for current sharing between the phases.

- Tie the TRACK pins together and use a single soft-start capacitor to soft-start the regulator.
- Increase the soft-start current parameter by the number of paralleled channels when solving the soft-start equation. (Refer to the **Soft Start and Output Voltage Tracking** section).

Table 6: VFB Resistor Table vs. Various Output Voltages

V _{OUT}	0.6V	1.0V	1.2V	1.5V	1.8V	2.5V	3.3V	5V
R _{FB}	Open	90.9k	60.4k	40.2k	30.2k	19.1k	13.3k	8.25k

Input Capacitors

Connect the MxL7213 to a low impedance DC source. Use four 22μF ceramic input capacitors to reduce RMS ripple current on the regulator input.

A bulk input capacitor is required if the source impedance is high or the source capacitance is low. For additional bulk input capacitance, use a surface mount 47μF to 100μF aluminum electrolytic bulk capacitor.

Output Capacitors

The bulk output capacitors, denoted as C_{OUT} , need to have low enough effective series resistance (ESR) to meet output voltage ripple and transient requirements. The MxL7213 can use low ESR tantalum capacitors, low ESR polymer capacitors, ceramic capacitors or a combination for C_{OUT} . Refer to [Table 11](#) for C_{OUT} recommendations that optimize performance for different output voltages.

Pulse-Skipping Mode Operation

Pulse-skipping mode enables the module to skip cycles at light loads which reduces switching losses and increases efficiency at low to intermediate currents. To enable this mode, connect the $MODE_PLLIN$ pin to the $INTVCC$ pin.

Forced Continuous Operation

Forced continuous operation is recommended when fixed frequency is more important than light load efficiency, and when the lowest output ripple is desired. To enable this mode, connect the $MODE_PLLIN$ pin to GND.

Multiphase Operation

Multiphase operation is used to achieve output currents greater than 13A. It can be used with both MxL7213 channels to achieve one 26A output. It can also be used by paralleling multiple MxL7213s and running them out of phase to attain one single high current output, up to 100A. Ripple current in both the input and output capacitors is substantially lower using a multiphase design when the number of phases multiplied by the output voltage is less than the input voltage. Input RMS ripple current and output ripple amplitude is reduced by the number of phases used while the effective ripple frequency is multiplied by the number of phases used. The MxL7213 is a peak current mode controlled device which results in very good current sharing between parallel modules and balances the thermal loading.

Up to 8 phases can be paralleled by using each MxL7213 channel's PHASMD, $MODE_PLLIN$ and CLKOUT pins. When the CLKOUT pin is connected to the following stage's $MODE_PLLIN$ pin, the frequency and the phase of both devices are locked. Phase difference can be obtained between $MODE_PLLIN$ and CLKOUT of 120 degrees, 60 degrees or 90 degrees respectively by connecting the PHASMD pin to $INTVCC$, SGND or left floating. [Figure 21](#)

shows an example of parallel operation and [Figure 22](#) shows examples of 2-phase, 4-phase and 6-phase designs.

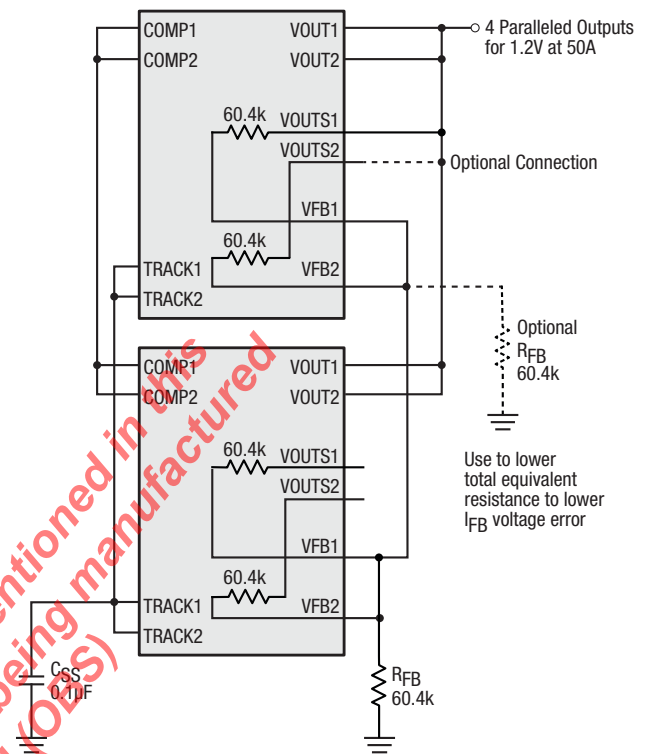

Figure 21: 4-Phase Parallel Configuration

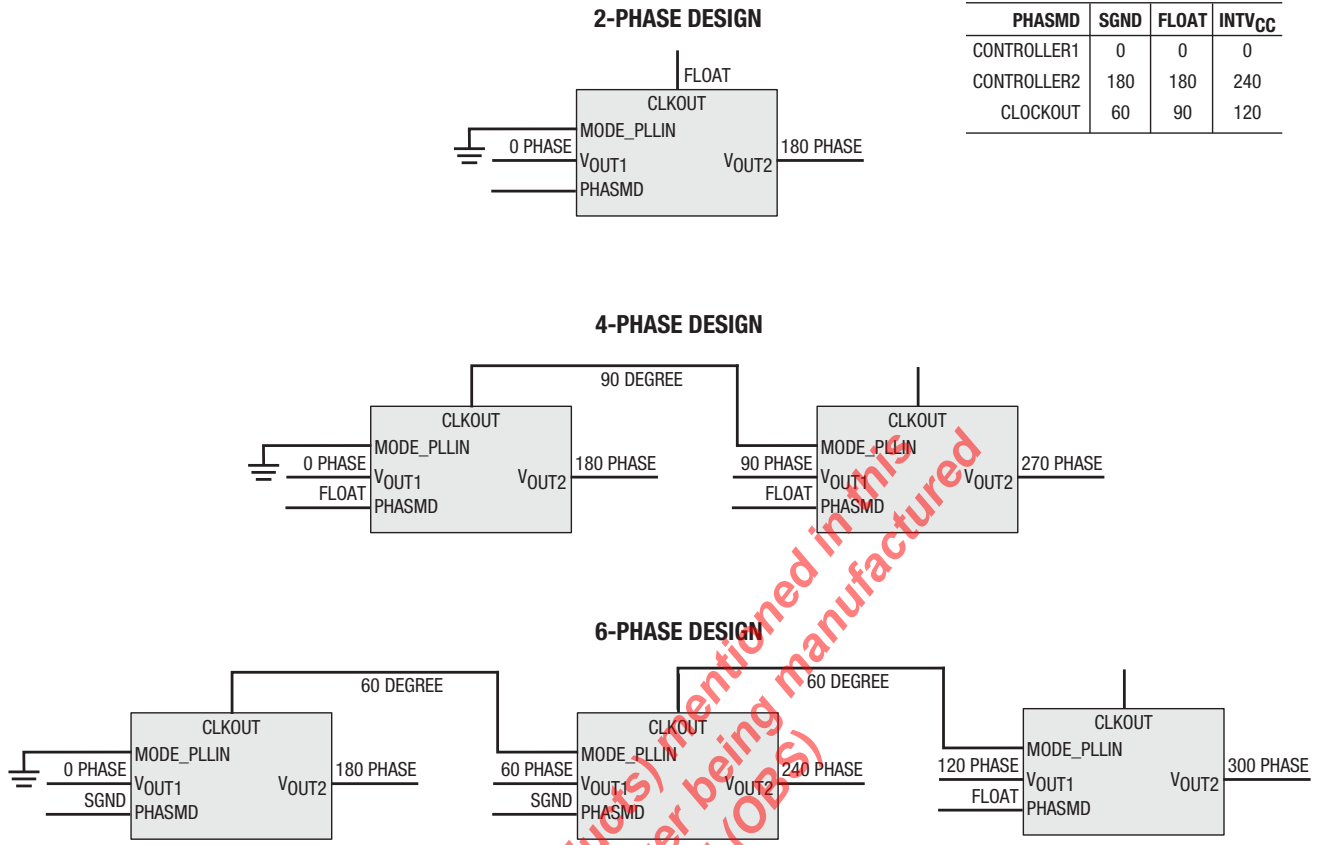

Figure 22: Examples of 2-Phase, 4-Phase and 6-Phase Operation with PHASMD Table

The product (or products) mentioned in this data sheet are no longer being manufactured and may not be ordered (OES)

Input RMS Ripple Current Cancellation

Figure 23 illustrates the RMS ripple current reduction that is expected as a function of the number of interleaved phases.

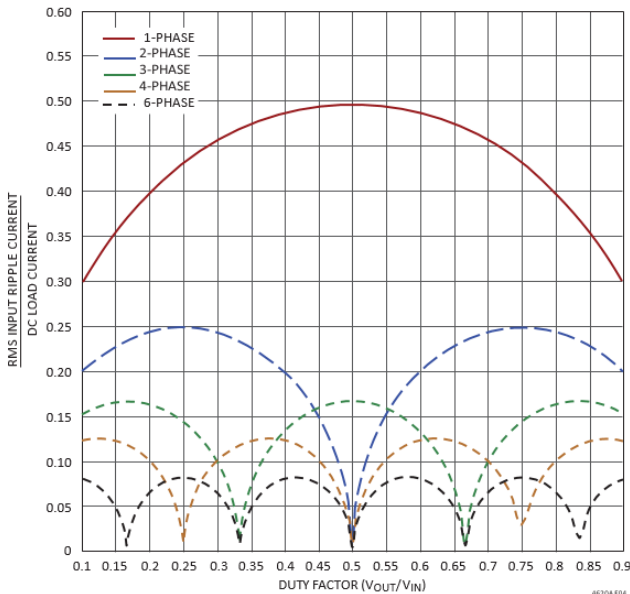

Figure 23: Normalized Input RMS Ripple Current vs. Duty Cycle, One to Six Phases

Frequency Selection and Phase-Lock Loop

To increase efficiency, the MxL7213 works over a range of frequencies. For lower output voltages or duty cycles, lower frequencies are recommended to lower MOSFET switching losses and improve efficiency. For higher output voltages or duty cycles, higher frequencies are recommended to limit inductor ripple current. Refer to the efficiency graphs and their operating frequency conditions. When selecting an operating frequency, keep the highest output voltage in mind.

Use an external resistor between the FSET pin and SGND to set the switching frequency. An accurate $10\mu\text{A}$ current source into the resistor sets a voltage that programs the frequency. Alternately, a DC voltage can be applied to FSET to program the frequency. Figure 24 illustrates the operating frequency versus FSET pin voltage.

An external clock with a frequency range of 250kHz to 780kHz and a voltage range of 0V to INTV_{CC} can be connected to the MODE_PLLIN pin. The high level threshold of the clock input is 1.6V and the low level threshold of the clock input is 1V.

The MxL7213 integrates the PLL loop filter components. Ensure that the initial switching frequency is set with an external resistor before locking to an external clock. Both regulators will operate in continuous mode while being synchronized to an external clock signal.

The PLL phase detector output charges and discharges the internal filter network with a pair of complementary current sources. When an external clock is connected, an internal switch disconnects the external FSET frequency resistor. The switching frequency then locks to the incoming external clock. If no external clock is connected, then the internal switch is on, which connects the external FSET frequency set resistor.

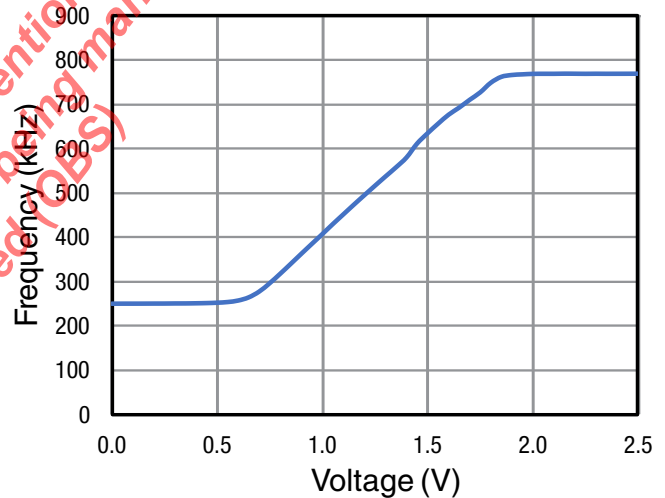

Figure 24: Operating Frequency vs. FSET Pin Voltage

Minimum On-Time

Minimum On-Time $t_{ON(MIN)}$ is the shortest time the controller can turn on the high-side MOSFET of either channel. Approaching this time may be more of an issue in low duty cycle applications. Use the following equation to make sure the on-time is above this minimum:

$$\frac{V_{OUT}}{V_{IN} \times FREQ} > t_{ON(MIN)}$$

If the on-time falls below this minimum, the channel will start to skip cycles. In this case, the output voltage continues to regulate, however output ripple increases. Lowering the switching frequency increases on-time. Minimum on-time specified in the electrical characteristics is 90ns.

Soft Start and Output Voltage Tracking

A capacitor C_{SS} can be connected from the TRACK pin to ground to implement soft start. The TRACK pin is charged by a $1.25\mu\text{A}$ current source up to the reference voltage and then on to $INTV_{CC}$. The MxL7213 has a smooth transition from TRACK to V_{OUT} as shown in Figure 25. If the RUN pin is below 1.2V, the TRACK pin is pulled low. The following equation can be used to calculate soft-start time, defined as when PGOOD asserts:

$$t_{SOFTSTART} = \left(\frac{C_{SS}}{1.25\mu\text{A}} \right) \times 0.65V$$

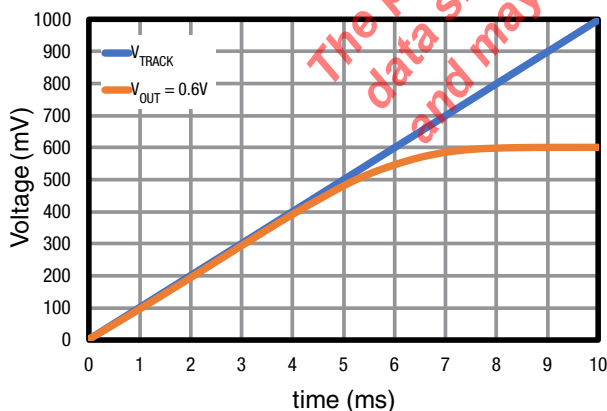

Figure 25: V_{OUT} and V_{TRACK} versus Time

The MODE_PLLIN pin selects between forced continuous mode or pulse-skipping mode during steady-state operation. Regardless of the mode selected, the module channels will always start in pulse-skipping mode up to $TRACK = 0.5V$. Between $TRACK = 0.5V$ and $0.54V$, it will operate in forced continuous mode. Once $TRACK > 0.54V$, it will follow the selected mode.

The TRACK pins can be used to externally program the output voltage tracking. The output may be tracked up and down with another regulator. The master regulator's output is divided down with an external resistor divider that is the same as the slave regulator's feedback divider to implement coincident tracking. Note that each MxL7213 channel has an internal accurate $60.4k\Omega$ for the top feedback resistor. Refer to the equation below, which is applicable for $V_{TRACK(SLAVE)} < 0.8V$. An example of coincident tracking is shown in Figure 26.

$$V_{OUT(SLAVE)} = \left(1 + \frac{60.4k}{R_{TA}} \right) \times V_{TRACK(SLAVE)}$$

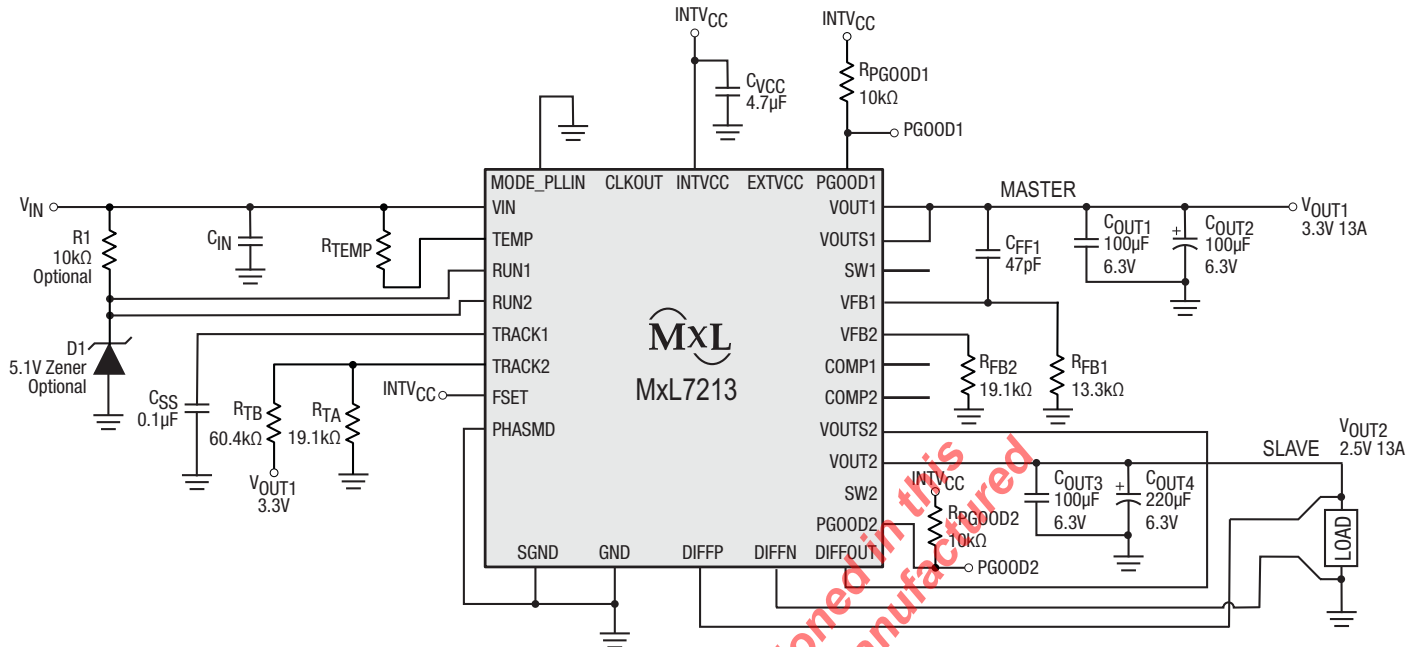

Figure 26: Example of Output Tracking Application Circuit

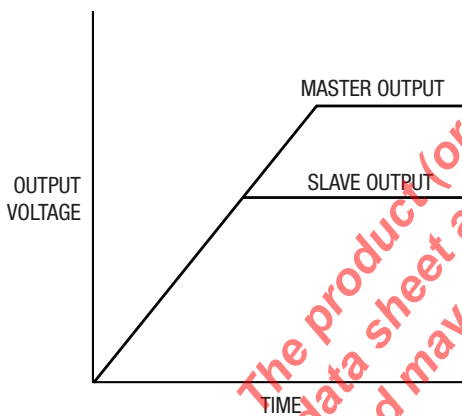

Figure 27: Output Coincident Tracking Waveform

The ramping voltage is applied to the track pin of the slave. Since the same resistor values are used to divide down the output of the master and to set the output of the slave, the slave tracks with the master coincidentally until its final value it achieved. The master continues from the slave's regulation point to its final value. In Figure 26, R_{TA} is equal to R_{FB2} for coincident tracking.

Ratiometric power up can be implemented by tying the TRACK pins together and connecting a capacitor from TRACK to ground. For existing designs where this is not

possible, populate R_{TA} with the same capacitor as the master's TRACK capacitor and do not populate R_{TB} . Capacitors with 10% accuracy are recommended.

Power Good

Each channel's open drain PGOOD pin can be used to monitor if its respective V_{OUT} is outside $\pm 10\%$ of the set point. The PGOOD pin is pulled low when the output of either channel is outside the monitoring window, the RUN pin is below its threshold (1.25V), or the MxL7213 is in the soft start or tracking phase. The PGOOD pin will flag power good immediately when both VFB pins are within the monitoring window. Note that there is an internal 20 μ s delay when VFB voltage goes out of the monitoring window.

If desired, a pull up resistor can be connected from the PGOOD pins to a supply voltage with a maximum level of $\leq 6V$.

Stability and Compensation

The MxL7213 is internally compensated across the range of all input and output voltages so additional compensation is not typically required. Table 11 covers most application requirements.

For low output capacitance or low output voltage applications, sometimes a reasonable loop bandwidth and improved phase margin can be obtained by adding a series R-C circuit between the COMP pin and SGND.

Additional Compensation Information

When the loop gain crosses 0dB at a slope steeper than -20dB / decade, the phase margin sometimes can be inadequate. This is when a small C_{FF} capacitor may offer some help. This C_{FF} capacitor is connected between the VOUTS and FB pins and is in parallel with the 60.4k Ω internal upper feedback resistor. The C_{FF} , together with the upper and lower feedback resistors, form a lead compensation network that inserts a "Zero" in the loop at a frequency followed by a "Pole" at a higher frequency. This gives the loop a phase boost mainly between the Zero and Pole frequencies.

C_{FF} , in conjunction with the upper 60.4k feedback resistor located inside the module, creates a feedback "Zero" (Fz).

$$F_z = \frac{1}{2 \times \pi \times 60400 \times C_{FF}}$$

This added zero makes it easier for high frequency signals to pass from the output back to the FB pin which helps boost the loop's phase margin.

The "Pole" in the lead compensation network can be calculated as:

$$F_p = \frac{60400 + R_{FB}}{2\pi \times 60400 \times R_{FB} \times C_{FF}}$$

For maximum effect, C_{FF} should be selected to place the peak of the phase boost right at the crossover frequency. Figure 28 shows the available phase boost normalized to the Fz frequency of 1.

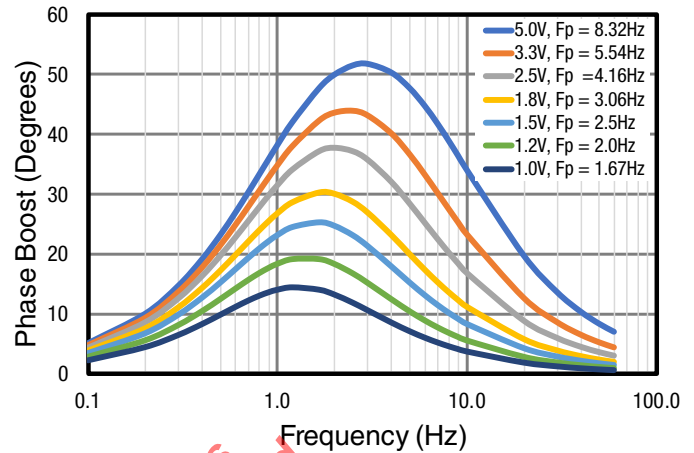

Figure 28: C_{FF} Phase Boost vs. Frequency F_{zero} Normalized to 1

As a starting point, calculate C_{FF} from the following equation, where F_{CO} is the crossover frequency.

$$C_{FF} = \frac{1}{2 \times \pi \times 60400 \times F_{CO}}$$

Since the addition of a C_{FF} also brings about a gain boost, the final crossover frequency will increase somewhat. So it may take several iterations to achieve the highest phase margin.

Enabling the Channels

The RUN1 and RUN2 pins enable and disable the module's two channels. If either channel is activated using a run pin, then INTVCC is activated. The typical enable threshold of the RUN pins is 1.25V, with a hysteresis of 150mV and a maximum of 1.4V. For 5V operation, they can be pulled up to VIN. For higher than 5V operation, a 10k Ω to 100k Ω resistor and 5V Zener diode can be used to enable the channels.

Alternately, the RUN pins can be left floating and the channels will turn on upon application of V_{IN}. For output voltage sequencing applications, the RUN pins can be connected to another channel's or device's PGOOD pins.

When using paralleled mode, connect the RUN pins together and use a single control. See Figure 20.

INTV_{CC} and EXTV_{CC}

The VIN input voltage powers an internal 5V low dropout regulator. The regulator output (INTVCC) provides voltage to the control circuitry of the module. Alternatively, the EXTVCC pin allows an external 5V supply to be used to eliminate the 5V LDO power dissipation in power sensitive applications.

Differential Remote Sense Amplifier

For output voltages ≤3.3V, the MxL7213’s differential remote sense amplifier can be used to accurately sense voltages at the load. This is particularly useful in high current load conditions. The DIFFP and DIFFN pins must be connected properly to the remote load point, and the DIFFOUT pin must be connected to the corresponding VOUTS1 or VOUTS2 pin.

SW Pins

Use the SW pins to monitor the switching node of each channel. These pins are generally used for testing or monitoring. During normal operation, these pins should be unconnected and left floating. However, in conjunction with an external series R-C snubber circuit, these pins can be used to dampen ringing on the switch node which may be caused by LC parasitics in the switched current paths.

Temperature Monitoring (TEMP)

An internal temperature sensing diode / PNP transistor is used to monitor its V_{BE} voltage over temperature, thus serving as a temperature monitor. Its forward voltage and temperature coefficient are shown in the electrical characteristics section and plotted in Figure 29. It is connected to VIN through a pullup resistor R_{TEMP} to limit the current to 100µA. It is recommended to set a 60µA minimum current in applications where V_{IN} varies over a wide range. See Figure 30 for an example on how to use this feature.

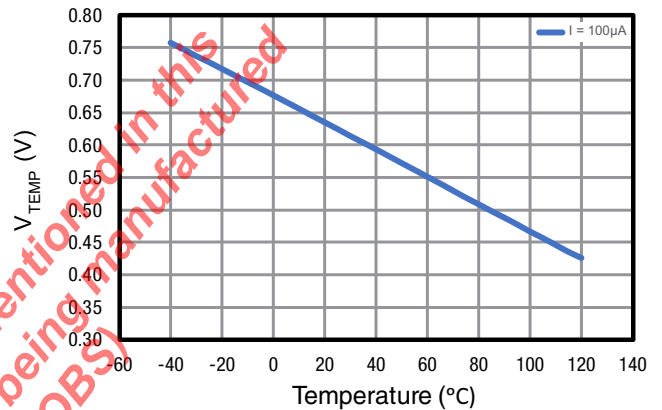

Figure 29: Diode Voltage vs. Temperature

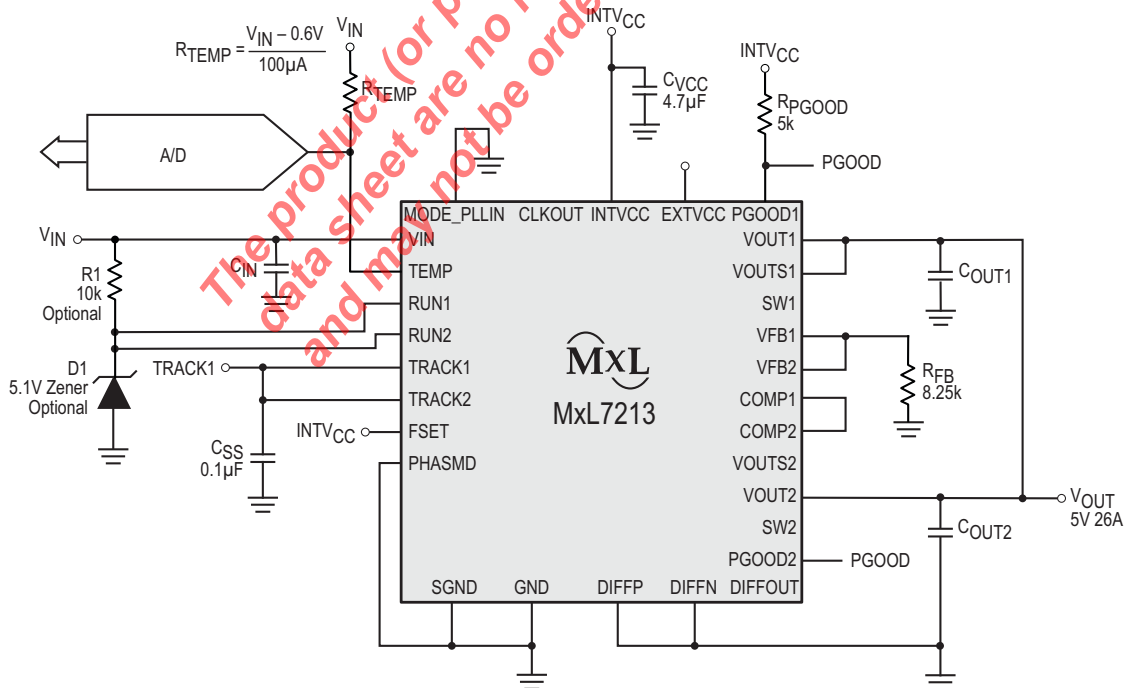

Figure 30: 2-Phase, 5V at 26A with Temperature Monitoring

Fault Protection

The MxL7213 modules support overcurrent, output overvoltage, and overtemperature protection.

The overcurrent triggers at a nominal load of 20A. Overcurrent during four consecutive switching cycles initiates a hiccup mode. During hiccup, the high-side and low-side MOSFETs are turned off for 100ms. A soft start is attempted following the hiccup. If the overcurrent persists, the hiccup will continue.

The overvoltage triggers when the output voltage is 10% above set-point and the high-side MOSFET is kept off while the low-side MOSFET turns on, clamping the output voltage.

The overtemperature triggers at 145°C and turns off the two MOSFETs. When the temperature cools down below 130°C, the module soft-starts.

A fuse or circuit breaker should be selected to limit the current to the regulator during overvoltage in case of an internal top MOSFET fault. If the internal top MOSFET fails, then turning it off will not resolve the overvoltage, thus the internal bottom MOSFET will turn on indefinitely trying to protect the load. Under this fault condition, the input voltage will source very large currents to ground through the failed internal top MOSFET and enabled internal bottom MOSFET. This can cause excessive heat and board damage depending on how much power the input voltage can deliver to this system. A fuse or circuit breaker can be used as a secondary fault protector in this situation.

Thermal Considerations and Output Current Derating

The design of the MxL7213 module removes heat from the bottom side of the package effectively. Thermal resistance from the bottom substrate material to the printed circuit board is very low.

Proper thermal design is critical in controlling device temperatures and in achieving robust designs. There are many factors that affect the thermal performance. One key factor is the temperature rise of the devices in the package, which is a function of the thermal resistances of the devices inside the package and the power being dissipated. The thermal resistances of the MxL7213 are shown in the “Operating Ratings” section of this datasheet. The JEDEC Θ_{JA} thermal resistance provided is based on tests that comply with the JESD51-2A “Integrated Circuit Thermal Test Method Environmental Conditions – Natural Convection” standard. JESD51 is a group of standards whose intent is to provide comparative data based on a standard test condition which includes a defined board construction. Since the actual board design in the final application will be different from the board defined in the standard, the thermal resistances in the final design may be different from those shown.

Figure 33, Figure 34, Figure 36, Figure 37 and Figure 39 show output current derating versus ambient temperature for various V_{IN} and V_{OUT} (V_{IN} / V_{OUT}) ratios with 0, 200, and 400 LFM of airflow. The total package power dissipation (P_{PKG}) is dependent on the final application and is the sum of the losses for the two channels. The power losses for a channel will depend mainly on the input voltage, output voltage, and output current. Figure 32, Figure 35 and Figure 38 show the power losses for input voltages of 5V and 12V and for V_{OUT} voltages of 1V, 2.5V, and 5.0V respectively (V_{IN} / V_{OUT}).

Power Derating

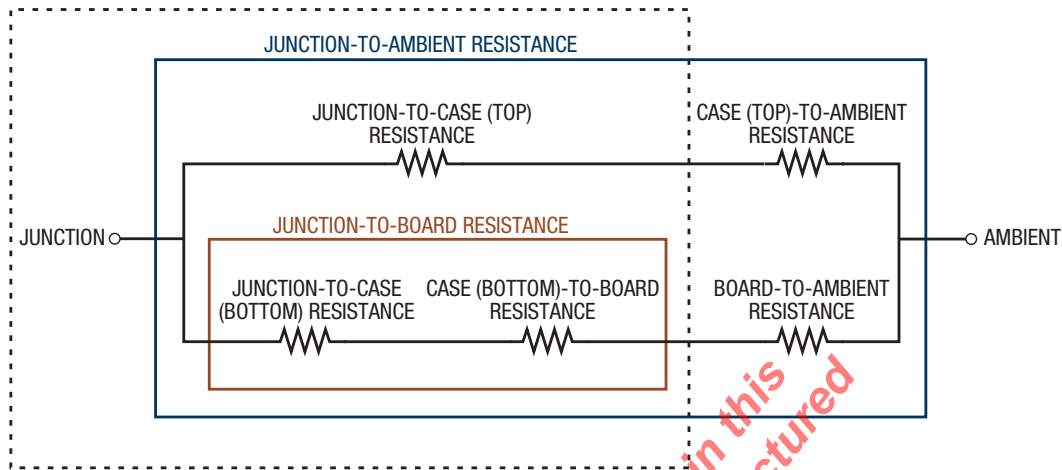

Figure 31: Graphical Representation of Thermal Coefficients

Table 7: θ_{JA} and Derating Curves Corresponding to 1.0V Output

Derating Curve	V_{IN} (V)	Power Loss Curve	Airflow (LFM)	LGA θ_{JA} ($^{\circ}C/W$)	BGA θ_{JA} ($^{\circ}C/W$)
Figure 33, Figure 34	5, 12	Figure 32	0	7	7
Figure 33, Figure 34	5, 12	Figure 32	200	5.5	5.5
Figure 33, Figure 34	5, 12	Figure 32	400	5	5

Table 8: θ_{JA} and Derating Curves Corresponding to 2.5V Output

Derating Curve	V_{IN} (V)	Power Loss Curve	Airflow (LFM)	LGA θ_{JA} ($^{\circ}C/W$)	BGA θ_{JA} ($^{\circ}C/W$)
Figure 36, Figure 37	5, 12	Figure 35	0	7	7
Figure 36, Figure 37	5, 12	Figure 35	200	6	6
Figure 36, Figure 37	5, 12	Figure 35	400	4.5	4.5

Table 9: θ_{JA} and Derating Curves Corresponding to 5V Output

Derating Curve	V_{IN} (V)	Power Loss Curve	Airflow (LFM)	LGA θ_{JA} ($^{\circ}C/W$)	BGA θ_{JA} ($^{\circ}C/W$)
Figure 39	12	Figure 38	0	7	7
Figure 39	12	Figure 38	200	6	6
Figure 39	12	Figure 38	400	4.5	4.5

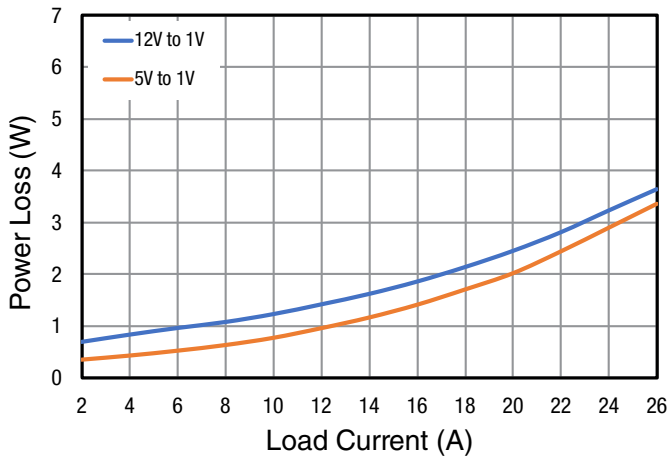

Figure 32: Power Loss, $V_{OUT} = 1.0V$

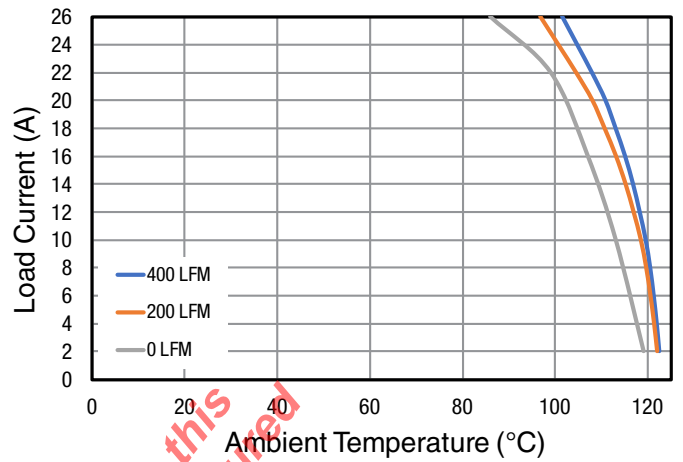

Figure 33: Current Derating, $V_{IN} = 5V, V_{OUT} = 1.0V$

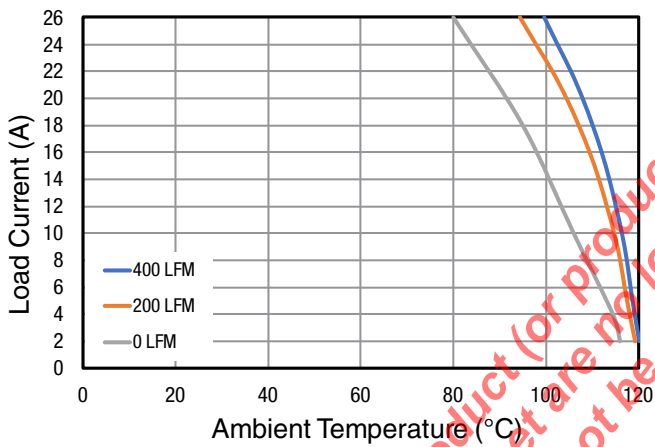

Figure 34: Current Derating, $V_{IN} = 12V, V_{OUT} = 1.0V$

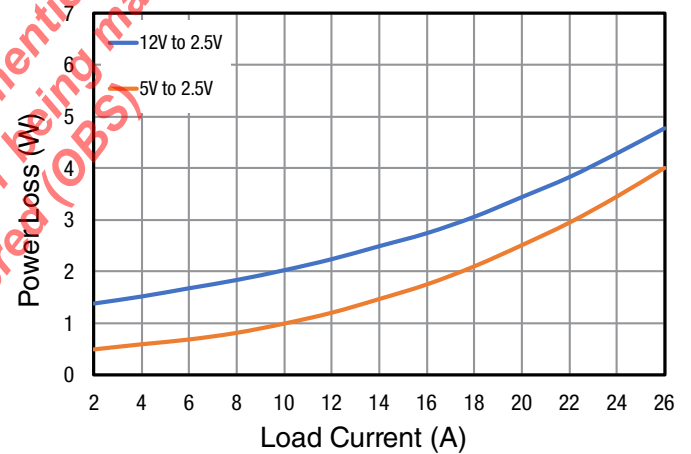

Figure 35: Power Loss, $V_{OUT} = 2.5V$

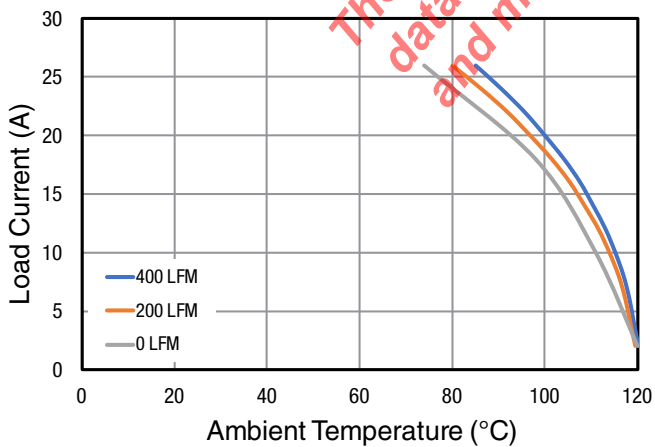

Figure 36: Current Derating, $V_{IN} = 5V, V_{OUT} = 2.5V$

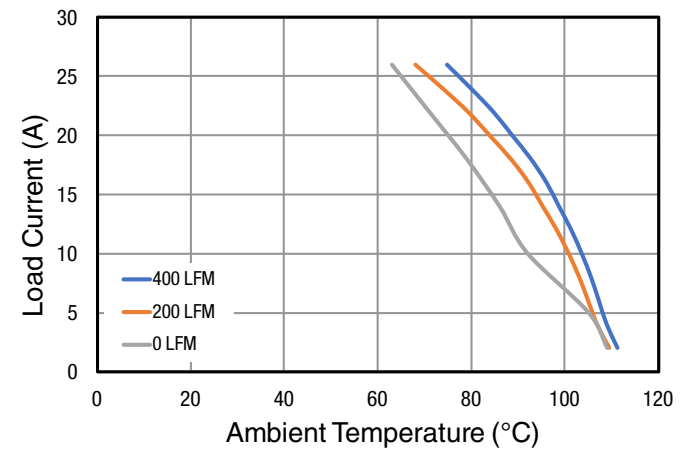

Figure 37: Current Derating, $V_{IN} = 12V, V_{OUT} = 2.5V$

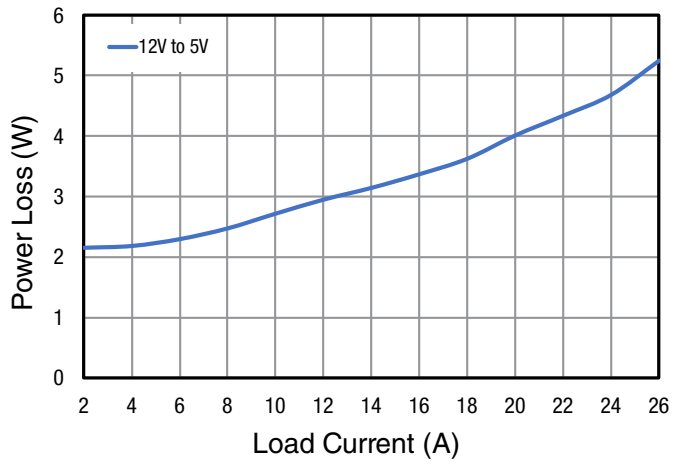

Figure 38: Power Loss, $V_{OUT} = 5V$

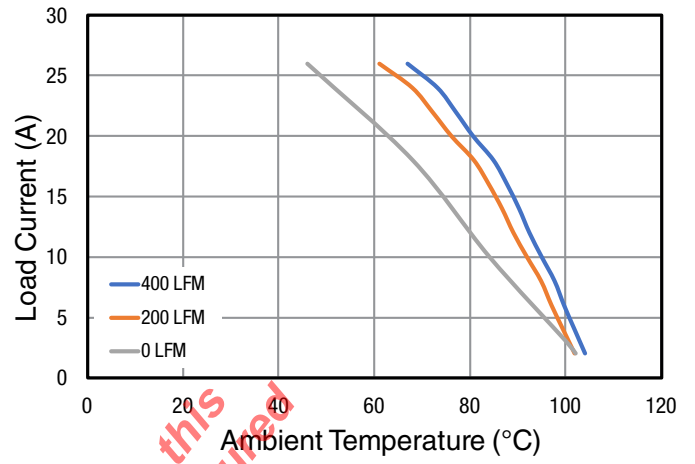

Figure 39: Current Derating, $V_{IN} = 12V$, $V_{OUT} = 5V$

The product (or products) mentioned in this data sheet are no longer being manufactured and may not be ordered (OBS)

Table 10: Capacitors Used for Output Voltage Response Matrix

Vendor	Value	Part Number	ESR (mΩ)
Murata, C _{OUT1} Ceramic	100μF, 6.3V	GRM32ER60J107ME20L	~2
Taiyo Yuden, C _{OUT1} Ceramic	100μF, 6.3V	JMK325BJ107MY	~2
Panasonic POSCAP, C _{OUT2}	470μF, 6.3V	6TPF470MAH	10
Panasonic POSCAP, C _{OUT2}	220μF, 6.3V	6TPF220ML	12
Panasonic POSCAP, C _{OUT2}	220μF, 2.5V	2R5TPE220M9	9
Panasonic POSCAP, C _{OUT2}	100μF, 6.3V	6TPE100MI	18
Nichicon, C _{IN} Bulk	150μF, 25V	UCD1E151MNL1GS	

Table 11: Output Voltage Response vs. Component Matrix

V _{OUT} (V)	C _{IN} (CERAMIC) (μF)	C _{IN} ⁽¹⁾ (BULK) (μF)	C _{OUT1} (CERAMIC) (μF)	C _{OUT2} (BULK) (μF)	C _{FF} (pF)	V _{IN} (V)	DROOP (mV)	P-P DEVIATION at 6A LOAD STEP (mV)	Recovery Time (μs)	LOAD STEP (A/μs)	R _{FB} (kΩ)	FREQ (kHz)
1	3 x 22	150	100	2 x 470	180	5	27	54	15	6	90.9	400
1	3 x 22	150	100	2 x 470	180	12	26	56	15	6	90.9	400
1	3 x 22	150	3 x 100	470	180	12	40	81	17	6	90.9	400
1.2	3 x 22	150	3 x 100	470	180	12	39	79	15	6	60.4	500
1.2	3 x 22	150	100	2 x 470	180	5	28	57	16	6	60.4	500
1.2	3 x 22	150	100	2 x 470	180	12	28	56	16	6	60.4	500
1.5	3 x 22	150	100	2 x 470	180	5	26	53	21	6	40.2	550
1.5	3 x 22	150	100	2 x 470	180	12	25	52	21	6	40.2	550
1.5	3 x 22	150	100	220	100	12	51	104	22	6	40.2	550
1.8	3 x 22	150	100	220	47	12	51	106	14	6	30.2	600
1.8	3 x 22	150	100	220	47	5	54	110	14	6	30.2	600
2.5	3 x 22	150	100	220		12	47	100	20	6	19.1	650
2.5	3 x 22	150	3 x 100		62	12	73	155	25	6	19.1	650
3.3	3 x 22	150	100	100	47	12	65	134	20	6	13.3	700
3.3	3 x 22	150	2 x 100		47	12	96	198	25	6	13.3	700
5	3 x 22	150	100		22	12	172	356	25	6	8.25	750
5	3 x 22	150		100		12	126	260	15	6	8.25	750

1. Bulk capacitance is optional if V_{IN} has very low input impedance.

Layout Guidelines and Example

The MxL7213's high level of integration simplifies PCB board design. However, some layout considerations are still recommended for optimal electrical and thermal performance.

- Use large PCB copper areas for high current paths, including VIN, VOUT1 and VOUT2 and GND to minimize conduction loss and thermal stress in the PCB.
- Use a dedicated power ground layer, placed under the MxL7213.
- Use multiple vias to interconnect the top layer and other power layers to minimize via conduction loss and module thermal stress.
- Cap or plate over any vias that are directly placed on the pad.

- Use a separated SGND ground copper area for components that are connected to the signal pins. The SGND to GND should be connected underneath the module.
- Place high frequency ceramic input and output capacitors next to the VIN, VOUT and PGND pins to minimize high frequency noise.
- When paralleling modules, connect the VFB, VOUT and COMP pins together closely with an internal layer. For soft-start mode, the TRACK pins may be tied together via a common capacitor.
- Test points can be brought out for monitoring the signal pins.

An example layout for the top PCB layer is recommended for both LGA and BGA packages in [Figure 40](#).

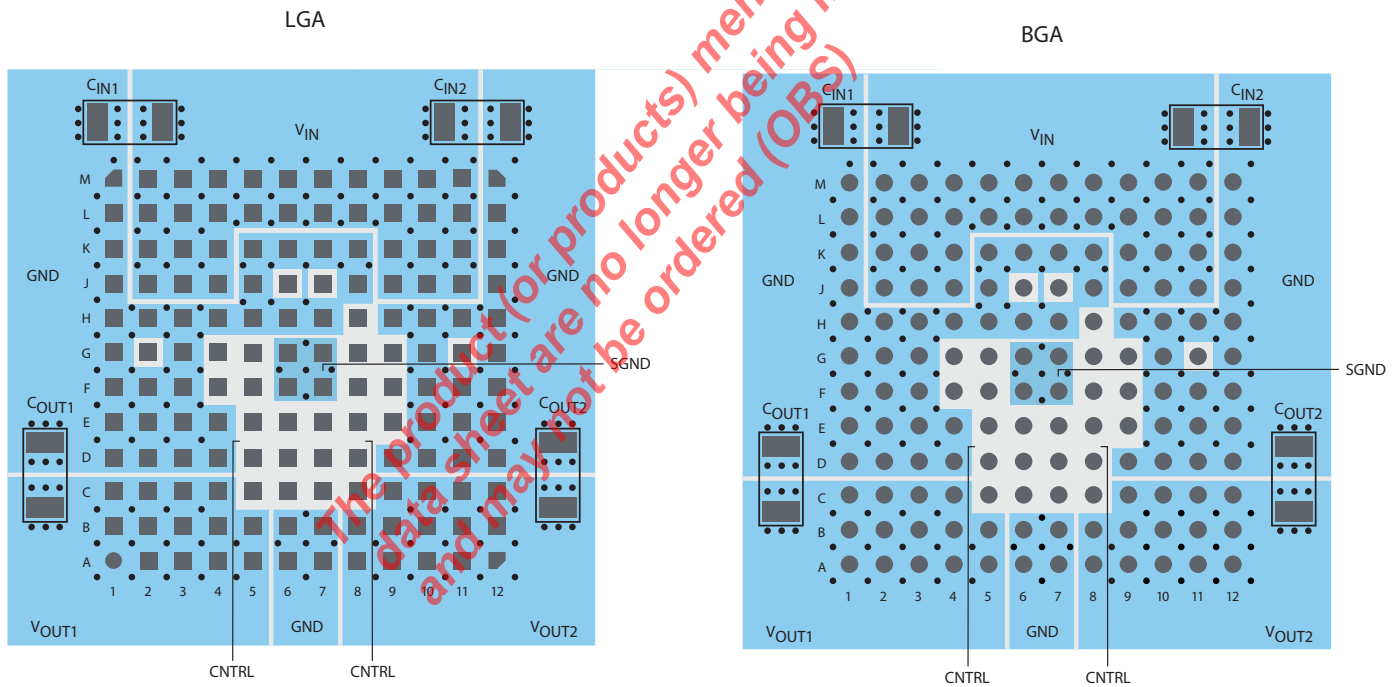
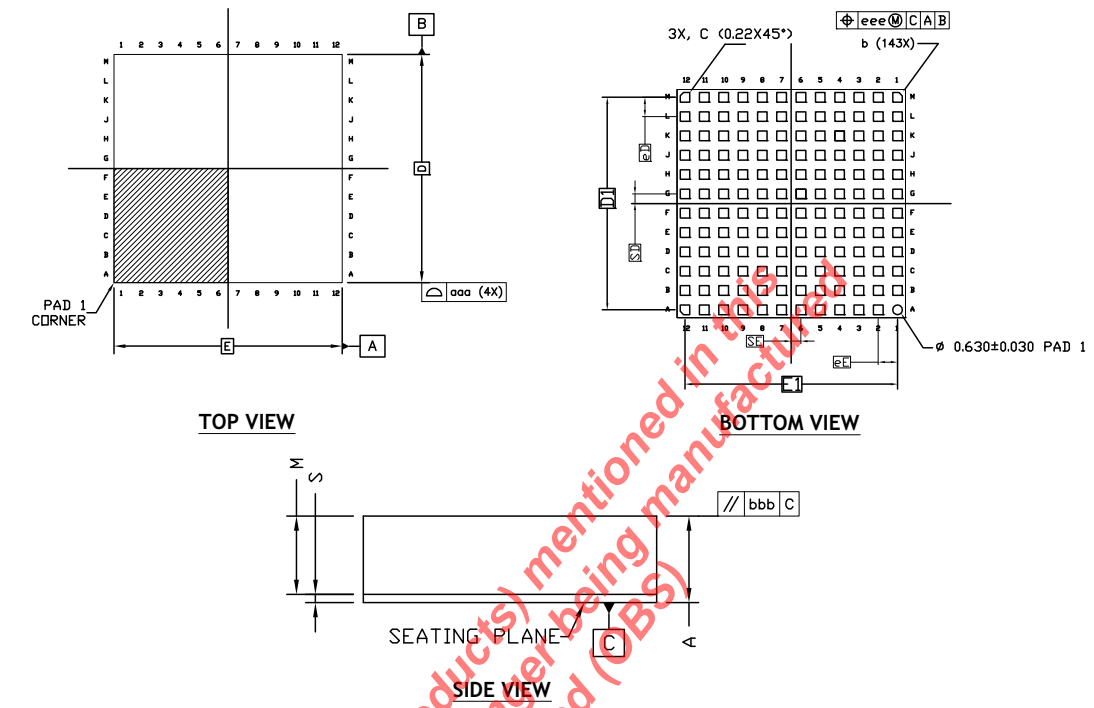

Figure 40: Recommended PCB Layout

Mechanical Dimensions

15mm x 15mm x 4.41mm LGA



	Symbol	Common Dimension
Package :		SIPLGA
Body Size :	X	E 15.000
	Y	D 15.000
LGA Pad Pitch :	X	eE 1.270
	Y	eD 1.270
Total Thickness :	A	4.410±0.10
Mold Thickness :	M	4.000±0.05
Substrate Thickness :	S	0.410±0.05
LGA Pad Size :	b	SO 0.630±0.030
Stand Off :	A1	N/A
Ball Width :		N/A
Package Edge Tolerance :	aaa	0.150
Mold Flatness :	bbb	0.100
Coplanarity:	ddd	N/A
LGA Pad Offset (Land) :	eee	0.050
Ball Offset (Ball) :	fff	N/A
LGA Pad Count :	n	144
Edge LGA Pad Center to Center :	X	E1 13.970
	Y	D1 13.970
Center Plg To Adjacent Center Of LGA Pad :	SE	0.635
	SD	0.635

TERMINAL DETAILS

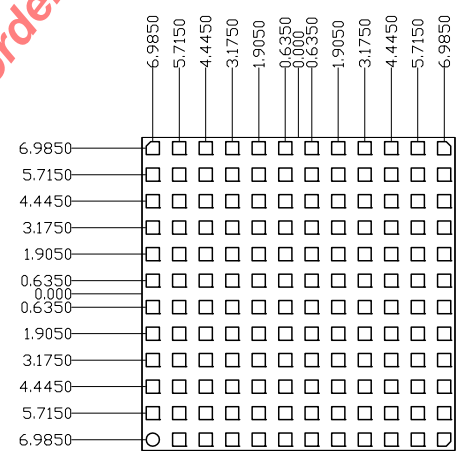

PAD LOCATION

NOTE : ALL DIMENSIONS ARE IN MILLIMETERS, ANGLES ARE IN DEGREES.

Drawing No.: POD-0000083

Revision: B

Figure 41: Mechanical Dimensions, LGA

Recommended Land Pattern and Stencil

15mm x 15mm x 4.41mm LGA

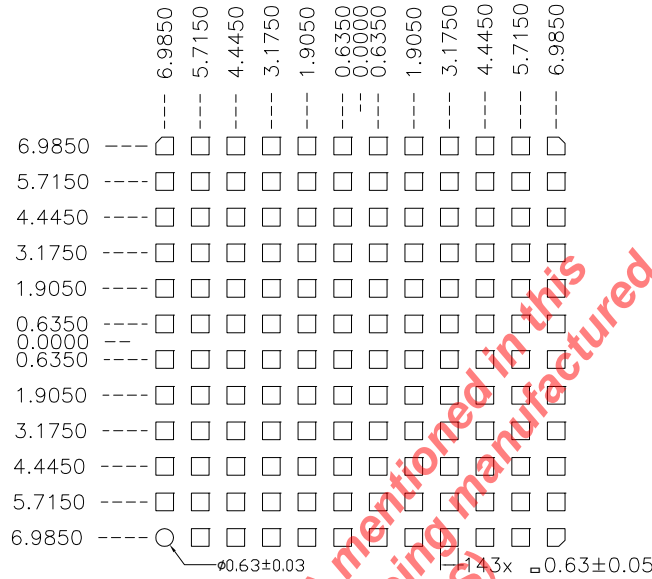

TYPICAL RECOMMENDED LAND PATTERN

The product (or products) mentioned in this data sheet are no longer being manufactured and may not be ordered (OBS)



TYPICAL RECOMMENDED STENCIL

NOTE : ALL DIMENSIONS ARE IN MILLIMETERS, ANGLES ARE IN DEGREES.

Drawing No.: POD-00000083

Revision: B

Figure 42: Recommended Land Pattern and Stencil, LGA

Mechanical Dimensions

15mm x 15mm x 5.01mm BGA

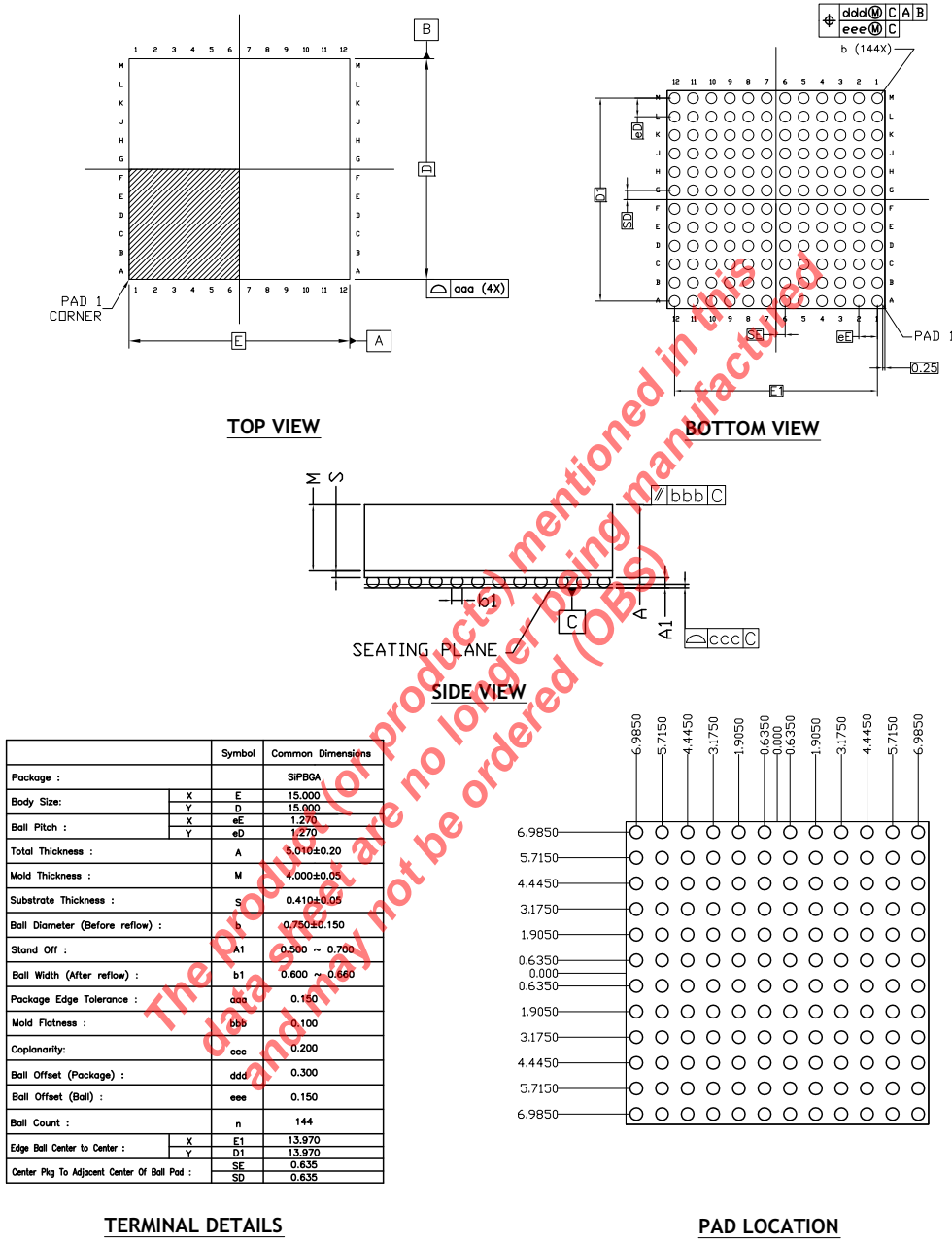

NOTE : ALL DIMENSIONS ARE IN MILLIMETERS, ANGLES ARE IN DEGREES.

Drawing No.: POD-00000084

Revision: B

Figure 43: Mechanical Dimensions, BGA

Recommended Land Pattern and Stencil

15mm x 15mm x 5.01mm BGA

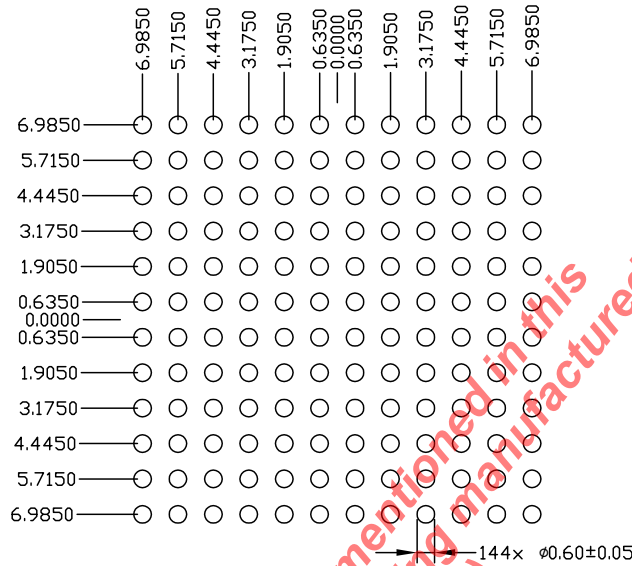

TYPICAL RECOMMENDED LAND PATTERN

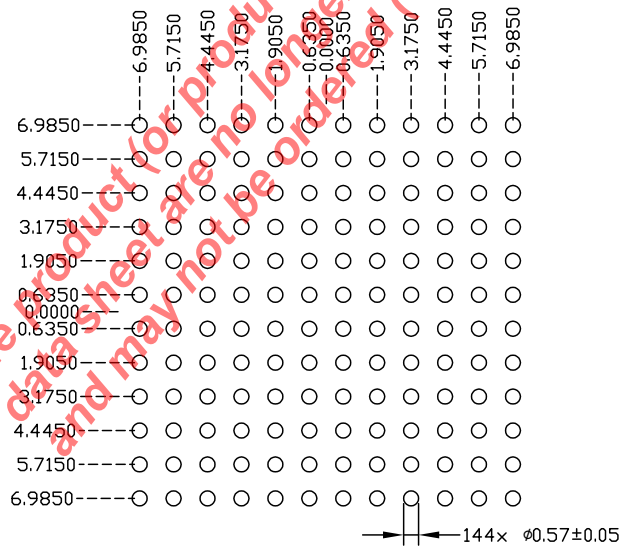

TYPICAL RECOMMENDED STENCIL

NOTE : ALL DIMENSIONS ARE IN MILLIMETERS, ANGLES ARE IN DEGREES.

Drawing No.: POD-0000084

Revision: B

Figure 44: Recommended Land Pattern and Stencil, BGA

MxL7213 Component Pinout

Table 12: MxL7213 Component Pinout

Pin ID	Function	Pin ID	Function	Pin ID	Function	Pin ID	Function	Pin ID	Function	Pin ID	Function
A1	VOUT1	B1	VOUT1	C1	VOUT1	D1	GND	E1	GND	F1	GND
A2	VOUT1	B2	VOUT1	C2	VOUT1	D2	GND	E2	GND	F2	GND
A3	VOUT1	B3	VOUT1	C3	VOUT1	D3	GND	E3	GND	F3	GND
A4	VOUT1	B4	VOUT1	C4	VOUT1	D4	GND	E4	GND	F4	MODE_PLLIN
A5	VOUT1	B5	VOUT1	C5	VOU1S1	D5	VFB1	E5	TRACK1	F5	RUN1
A6	GND	B6	GND	C6	FSET	D6	SGND	E6	COMP1	F6	SGND
A7	GND	B7	GND	C7	SGND	D7	VFB2	E7	COMP2	F7	SGND
A8	VOUT2	B8	VOUT2	C8	VOU2S2	D8	TRACK2	E8	DIFFP	F8	DIFFOUT
A9	VOUT2	B9	VOUT2	C9	VOUT2	D9	GND	E9	DIFFN	F9	RUN2
A10	VOUT2	B10	VOUT2	C10	VOUT2	D10	GND	E10	GND	F10	GND
A11	VOUT2	B11	VOUT2	C11	VOUT2	D11	GND	E11	GND	F11	GND
A12	VOUT2	B12	VOUT2	C12	VOUT2	D12	GND	E12	GND	F12	GND
G1	GND	H1	GND	J1	GND	K1	GND	L1	GND	M1	GND
G2	SW1	H2	GND	J2	VIN	K2	VIN	L2	VIN	M2	VIN
G3	GND	H3	GND	J3	VIN	K3	VIN	L3	VIN	M3	VIN
G4	PHASMD	H4	GND	J4	VIN	K4	VIN	L4	VIN	M4	VIN
G5	CLKOUT	H5	GND	J5	GND	K5	GND	L5	VIN	M5	VIN
G6	SGND	H6	GND	J6	TEMP	K6	GND	L6	VIN	M6	VIN
G7	SGND	H7	GND	J7	EXTVCC	K7	GND	L7	VIN	M7	VIN
G8	PGOOD2	H8	INTVCC	J8	GND	K8	GND	L8	VIN	M8	VIN
G9	PGOOD1	H9	GND	J9	VIN	K9	VIN	L9	VIN	M9	VIN
G10	GND	H10	GND	J10	VIN	K10	VIN	L10	VIN	M10	VIN
G11	SW2	H11	GND	J11	VIN	K11	VIN	L11	VIN	M11	VIN
G12	GND	H12	GND	J12	GND	K12	GND	L12	GND	M12	GND

Ordering Information

Table 13: Ordering Information⁽¹⁾

Ordering Part Number	Operating Temperature Range	MSL Rating	Lead-Free	Package	Packaging Method
MxL7213-AYA-T	-40°C ≤ T _J ≤ 125°C	3	Yes ⁽²⁾	LGA144 15x15	Tray
MxL7213-ABA-T				BGA144 15x15	
MxL7213-EVK-1	MxL7213 LGA Power Module Dual-Phase EVK				
MxL7213-EVK-3	MxL7213 BGA Power Module Dual-Phase EVK				

1. Refer to www.maxlinear.com/MxL7213 for most up-to-date Ordering Information.
2. Visit www.maxlinear.com for additional information on Environmental Rating.

The product (or products) mentioned in this data sheet are no longer being manufactured and may not be ordered (OBS)



MaxLinear, Inc.
5966 La Place Court, Suite 100
Carlsbad, CA 92008
760.692.0711 p.
760.444.8598 f.
www.maxlinear.com

The content of this document is furnished for informational use only, is subject to change without notice, and should not be construed as a commitment by MaxLinear, Inc. MaxLinear, Inc. assumes no responsibility or liability for any errors or inaccuracies that may appear in the informational content contained in this guide. Complying with all applicable copyright laws is the responsibility of the user. Without limiting the rights under copyright, no part of this document may be reproduced into, stored in, or introduced into a retrieval system, or transmitted in any form or by any means (electronic, mechanical, photocopying, recording, or otherwise), or for any purpose, without the express written permission of MaxLinear, Inc.

MaxLinear, Inc. does not recommend the use of any of its products in life support applications where the failure or malfunction of the product can reasonably be expected to cause failure of the life support system or to significantly affect its safety or effectiveness. Products are not authorized for use in such applications unless MaxLinear, Inc. receives, in writing, assurances to its satisfaction that: (a) the risk of injury or damage has been minimized; (b) the user assumes all such risks; (c) potential liability of MaxLinear, Inc. is adequately protected under the circumstances.

MaxLinear, Inc. may have patents, patent applications, trademarks, copyrights, or other intellectual property rights covering subject matter in this document. Except as expressly provided in any written license agreement from MaxLinear, Inc., the furnishing of this document does not give you any license to these patents, trademarks, copyrights, or other intellectual property.

MaxLinear, the MaxLinear logo, and any MaxLinear trademarks, MxL, Full-Spectrum Capture, FSC, G.now, AirPHY and the MaxLinear logo are all on the products sold, are all trademarks of MaxLinear, Inc. or one of MaxLinear's subsidiaries in the U.S.A. and other countries. All rights reserved. Other company trademarks and product names appearing herein are the property of their respective owners.