



A New Direction in Mixed-Signal

CLC2023

Dual, Low Distortion, Low Offset, RRIO Amplifier

General Description

The CLC2023 is a dual channel, high-performance, voltage feedback amplifier with low input voltage noise and ultra low distortion. The CLC2023 offers 6mV maximum input offset voltage, 3.5nV/√Hz broadband input voltage noise, and 0.00005% THD at 1kHz. It also provides 55MHz gain bandwidth product and 12V/μs slew rate making them well suited for applications requiring precision DC performance and high AC performance. This high-performance amplifier also offers a rail-to-rail input and output, simplifying single supply designs and offering larger dynamic range possibilities. The input range extends beyond the rails by 300mV.

The CLC2023 is designed to operate from 2.5V to 12V supplies and operate over the extended temperature range of -40°C to +125°.

FEATURES

- 6mV maximum input offset voltage
- 0.00005% THD at 1kHz
- 5.3nV/√Hz input voltage noise > 10kHz
- -90dB/-85dB HD2/HD3 at 100kHz, R_L = 100Ω
- <-100dB HD2 and HD3 at 10kHz, R_L = 1kΩ
- Rail-to-rail input and output
- 55MHz unity gain bandwidth
- 12V/μs slew rate
- -40°C to +125°C operating temperature range
- Fully specified at 3 and ±5V supplies
- CLC2023: ROHS compliant MSOP-8, SOIC-8 package options

APPLICATIONS

- Active filters
- Sensor interface
- High-speed transducer amp
- Medical instrumentation
- Probe equipment
- Test equipment
- Smoke detectors
- Hand-held analytic instruments
- Current sense applications

Ordering Information - [back page](#)

Typical Application

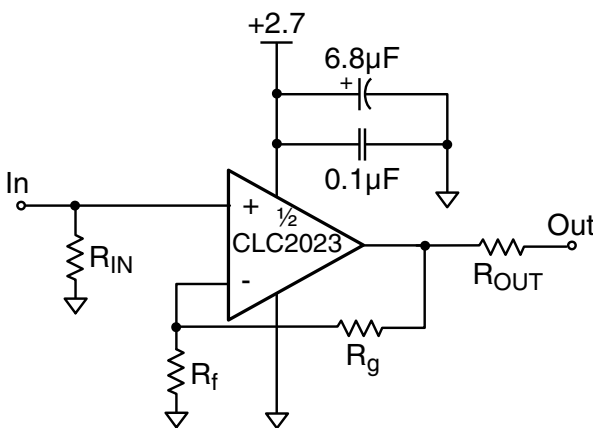

Crosstalk vs. Frequency

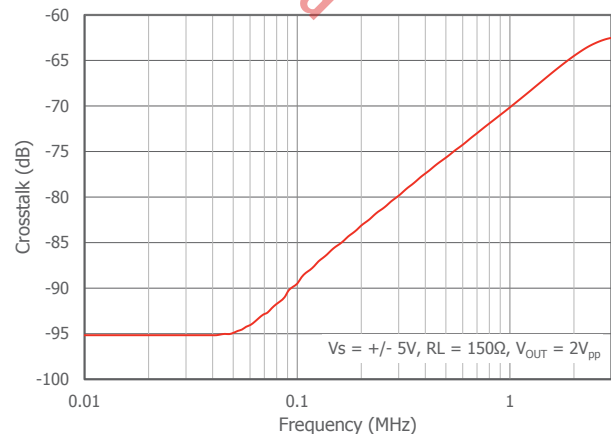

Absolute Maximum Ratings

Stresses beyond the limits listed below may cause permanent damage to the device. Exposure to any Absolute Maximum Rating condition for extended periods may affect device reliability and lifetime.

V_S 0V to +14V

V_{IN} $-V_S - 0.5V$ to $+V_S + 0.5V$

Operating Conditions

Supply Voltage Range 2.5V to 12V

Operating Temperature Range -40°C to 125°C

Junction Temperature 150°C

Storage Temperature Range -65°C to 150°C

Lead Temperature (Soldering, 10s) 260°C

Package Thermal Resistance

θ_{JA} (MSOP-8) $200^{\circ}\text{C}/\text{W}$

θ_{JA} (SOIC-8) $150^{\circ}\text{C}/\text{W}$

Package thermal resistance (θ_{JA}), JEDEC standard, multi-layer test boards, still air.

The product (or products) mentioned in this data sheet are no longer being manufactured and may not be ordered (OBS)

Electrical Characteristics at +3V

$T_A = 25^\circ\text{C}$, $V_S = +3\text{V}$, $R_f = 1\text{k}\Omega$, $R_L = 1\text{k}\Omega$ to $V_S/2$; $G = 2$; unless otherwise noted.

Symbol	Parameter	Conditions	Min	Typ	Max	Units
Frequency Domain Response						
GBWP	-3dB Gain Bandwidth Product	$G = 10$, $V_{OUT} = 0.05V_{pp}$		31		MHz
UGBW	Unity Gain Bandwidth	$V_{OUT} = 0.05V_{pp}$, $R_f = 0$		50		MHz
BW _{SS}	-3dB Bandwidth	$V_{OUT} = 0.05V_{pp}$		24		MHz
BW _{LS}	Large Signal Bandwidth	$V_{OUT} = 2V_{pp}$		3.3		MHz
Time Domain						
t_R , t_F	Rise and Fall Time	$V_{OUT} = 2\text{V}$ step; (10% to 90%)		150		ns
t_S	Settling Time to 0.1%	$V_{OUT} = 2\text{V}$ step		78		ns
OS	Overshoot	$V_{OUT} = 2\text{V}$ step		0.3		%
SR	Slew Rate	2V step		11		V/ μs
Distortion/Noise Response						
HD2	2nd Harmonic Distortion	2V _{pp} , 10kHz, $R_L = 1\text{k}\Omega$		-98		dBc
		2V _{pp} , 100kHz, $R_L = 100\Omega$		-85		dBc
HD3	3rd Harmonic Distortion	2V _{pp} , 10kHz, $R_L = 1\text{k}\Omega$		-95		dBc
		2V _{pp} , 100kHz, $R_L = 100\Omega$		-81		dBc
THD	Total Harmonic Distortion	1V _{pp} , 1kHz, $G = 1$, $R_L = 2\text{k}\Omega$		0.0005		%
e_n	Input Voltage Noise	>10kHz		5.5		nV/ $\sqrt{\text{Hz}}$
		>100kHz		3.9		nV/ $\sqrt{\text{Hz}}$
X _{TALK}	Crosstalk	1MHz		70		dB
DC Performance						
V_{IO}	Input Offset Voltage			0.088		mV
d_{VIO}	Average Drift			1.3		$\mu\text{V}/^\circ\text{C}$
I_B	Input Bias Current			-0.340		μA
dI_B	Average Drift			0.8		nA/ $^\circ\text{C}$
I_{OS}	Input Offset Current			0.2		μA
PSRR	Power Supply Rejection Ratio	DC		100		dB
A_{OL}	Open Loop Gain	$V_{OUT} = V_S / 2$		104		dB
I_S	Supply Current	per channel		1.85		mA
Input Characteristics						
R_{IN}	Input Resistance	Non-inverting, $G = 1$		30		M Ω
C_{IN}	Input Capacitance			1.1		pF
CMIR	Common Mode Input Range			-0.3 to 3.3		V
CMRR	Common Mode Rejection Ratio	DC, $V_{CM} = 0.5\text{V}$ to 2.5V		75		dB
Output Characteristics						
V_{OUT}	Output Swing	$R_L = 150\Omega$		0.085 to 2.80		V
		$R_L = 1\text{k}\Omega$		0.04 to 2.91		V
I_{OUT}	Output Current			+57, -47		mA
I_{SC}	Short Circuit Current	$V_{OUT} = V_S / 2$		+65, -52		mA

Electrical Characteristics at $\pm 5V$

$T_A = 25^\circ\text{C}$, $V_S = \pm 5V$, $R_f = 1k\Omega$, $R_L = 1k\Omega$ to GND; $G = 2$; unless otherwise noted.

Symbol	Parameter	Conditions	Min	Typ	Max	Units
Frequency Domain Response						
GBWP	-3dB Gain Bandwidth Product	$G = 10$, $V_{OUT} = 0.05V_{pp}$		35		MHz
UGBW	Unity Gain Bandwidth	$V_{OUT} = 0.05V_{pp}$, $R_f = 0$		55		MHz
BW _{SS}	-3dB Bandwidth	$V_{OUT} = 0.05V_{pp}$		25		MHz
BW _{LS}	Large Signal Bandwidth	$V_{OUT} = 2V_{pp}$		3.6		MHz
Time Domain						
t_R , t_F	Rise and Fall Time	$V_{OUT} = 2V$ step; (10% to 90%)		125		ns
t_S	Settling Time to 0.1%	$V_{OUT} = 2V$ step		80		ns
OS	Overshoot	$V_{OUT} = 2V$ step		0.3		%
SR	Slew Rate	4V step		12		V/ μ s
Distortion/Noise Response						
HD2	2nd Harmonic Distortion	$2V_{pp}$, 10kHz, $R_L = 1k\Omega$		-125		dBc
		$2V_{pp}$, 100kHz, $R_L = 100\Omega$		-90		dBc
HD3	3rd Harmonic Distortion	$2V_{pp}$, 10kHz, $R_L = 1k\Omega$		-127		dBc
		$2V_{pp}$, 100kHz, $R_L = 100\Omega$		-85		dBc
THD	Total Harmonic Distortion	$1V_{pp}$, 1kHz, $G = 1$, $R_L = 2k\Omega$		0.00005		%
e_n	Input Voltage Noise	$> 10\text{kHz}$		5.3		nV/ $\sqrt{\text{Hz}}$
		$> 100\text{kHz}$		3.5		nV/ $\sqrt{\text{Hz}}$
X_{TALK}	Crosstalk	1MHz		70		dB
DC Performance						
V_{IO}	Input Offset Voltage		-6	0.050	6	mV
d_{VIO}	Average Drift			1.3		$\mu\text{V}/^\circ\text{C}$
I_B	Input Bias Current		-2.6	-0.30	2.6	μA
dI_B	Average Drift			0.85		nA/ $^\circ\text{C}$
I_{OS}	Input Offset Current			0.2	0.7	μA
PSRR	Power Supply Rejection Ratio	DC	82	100		dB
A_{OL}	Open Loop Gain	$V_{OUT} = V_S / 2$	95	115		dB
I_S	Supply Current	per channel		2.2	2.75	mA
Input Characteristics						
R_{IN}	Input Resistance	Non-inverting, $G = 1$		30		M Ω
C_{IN}	Input Capacitance			1		pF
CMIR	Common Mode Input Range			± 5.3		V
CMRR	Common Mode Rejection Ratio	DC, $V_{CM} = -3V$ to $3V$	70	85		dB
Output Characteristics						
V_{OUT}	Output Swing	$R_L = 150\Omega$		-4.826 to 4.534		V
		$R_L = 1k\Omega$	-4.7	-4.93 to 4.85	4.7	V
I_{OUT}	Output Current			+60, -48		mA
I_{SC}	Short Circuit Current	$V_{OUT} = V_S / 2$		+65, -52		mA

CLC2023 Pin Configuration

MSOP-8 / SOIC-8

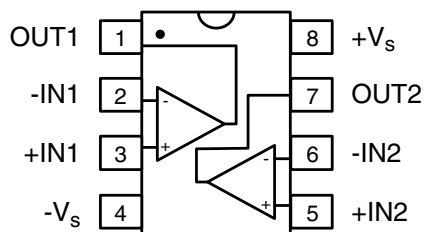

CLC2023 Pin Assignments

MSOP-8 / SOIC-8

Pin No.	Pin Name	Description
1	OUT1	Output, channel 1
2	-IN1	Negative input, channel 1
3	+IN1	Positive input, channel 1
4	-Vs	Negative supply
5	+IN2	Positive input, channel 2
6	-IN2	Negative input, channel 2
7	OUT2	Output, channel 2
8	+Vs	Positive supply

The product (or products) mentioned in this data sheet are no longer being manufactured and may not be ordered (OBS)

Typical Performance Characteristics

$T_A = 25^\circ\text{C}$, $V_S = \pm 5\text{V}$, $R_f = 1\text{k}\Omega$, $R_L = 1\text{k}\Omega$, $G = 2$; unless otherwise noted.

Non-Inverting Frequency Response

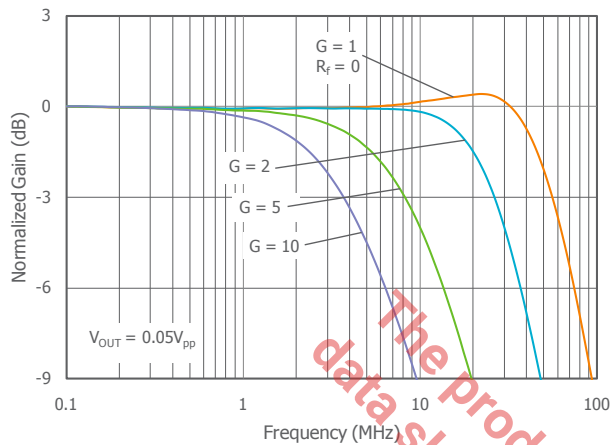

Inverting Frequency Response

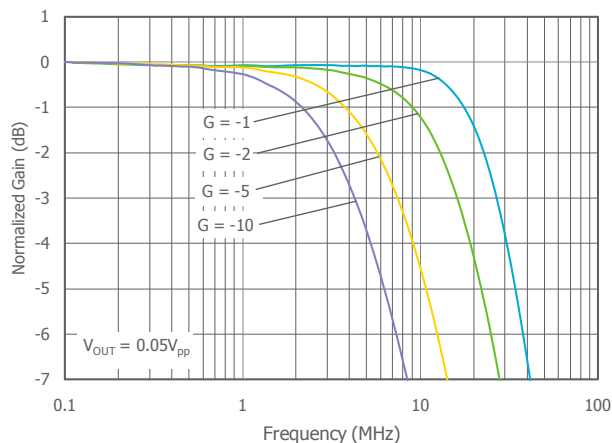

Frequency Response vs. C_L

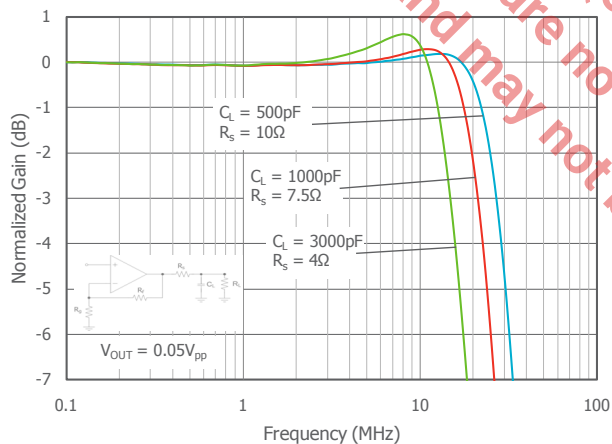

Frequency Response vs. C_L without R_S

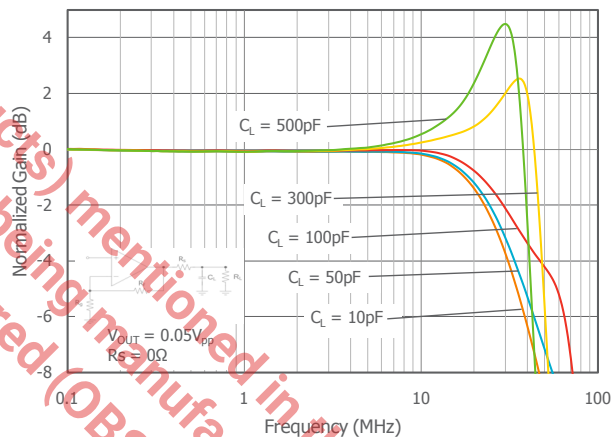

Frequency Response vs. V_{OUT}

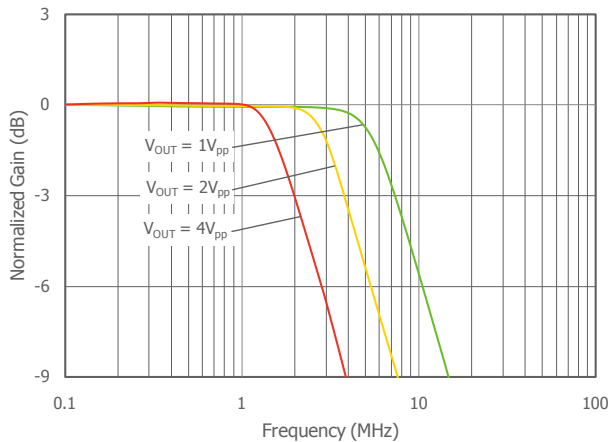

Frequency Response vs. R_L

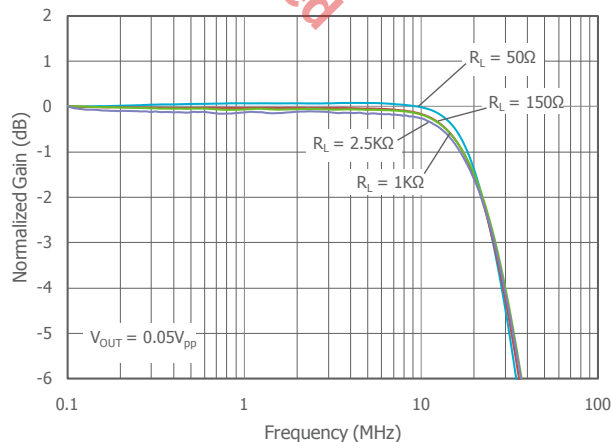

Typical Performance Characteristics

$T_A = 25^\circ\text{C}$, $V_S = \pm 5\text{V}$, $R_f = 1\text{k}\Omega$, $R_L = 1\text{k}\Omega$, $G = 2$; unless otherwise noted.

Non-Inverting Frequency Response at $V_S = 3\text{V}$

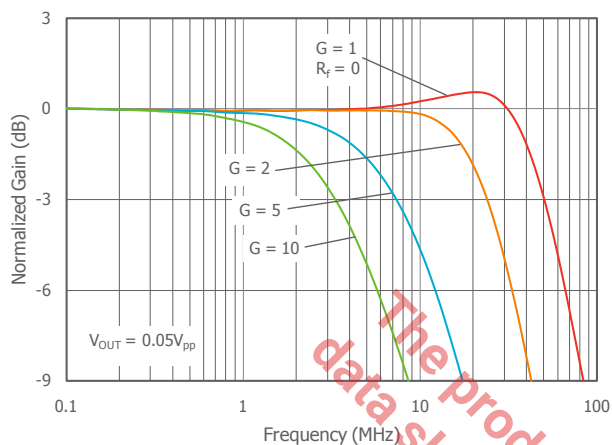

Inverting Frequency Response at $V_S = 3\text{V}$

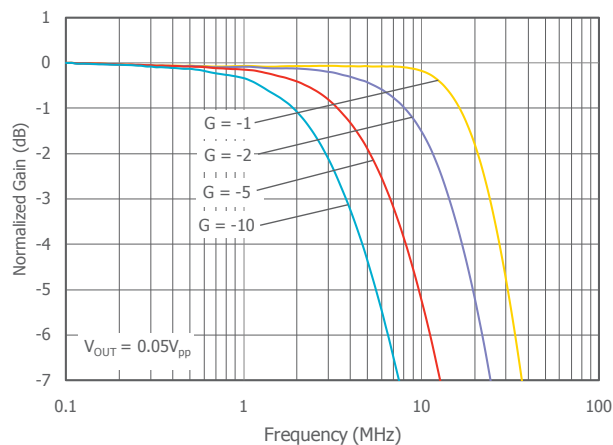

Frequency Response vs. V_{OUT} at $V_S = 3\text{V}$

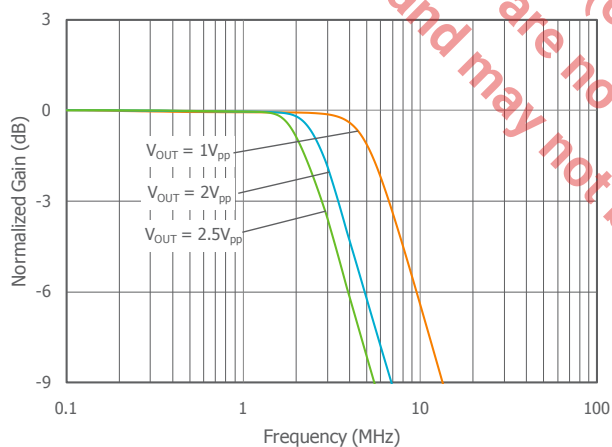

Frequency Response vs. R_L at $V_S = 3\text{V}$

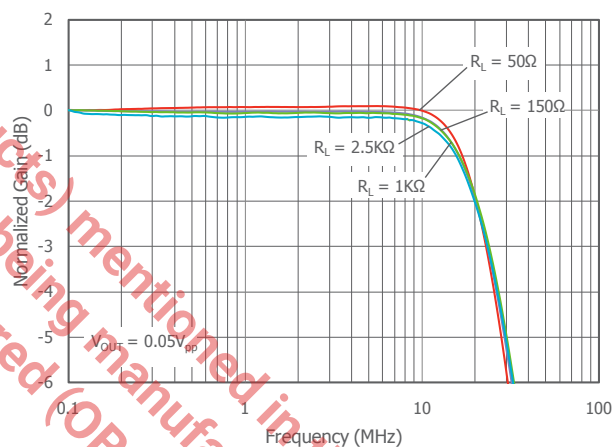

-3dB Bandwidth vs. Output Voltage at $V_S = 3\text{V}$

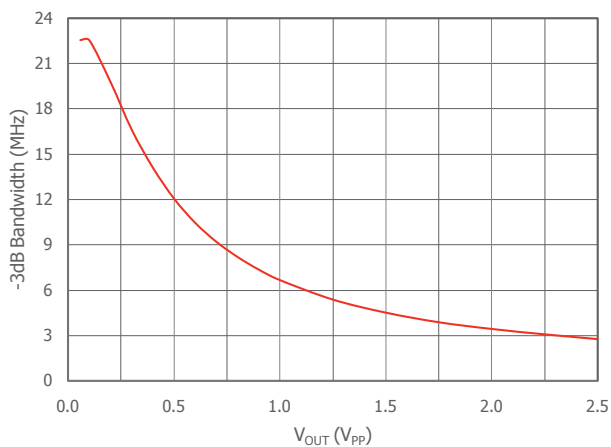

-3dB Bandwidth vs. Output Voltage

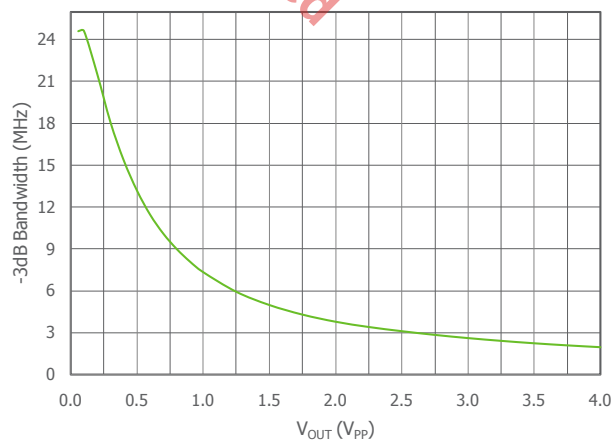

Typical Performance Characteristics

$T_A = 25^\circ\text{C}$, $V_S = \pm 5\text{V}$, $R_f = 1\text{k}\Omega$, $R_L = 1\text{k}\Omega$, $G = 2$; unless otherwise noted.

Open Loop Gain and Phase vs.

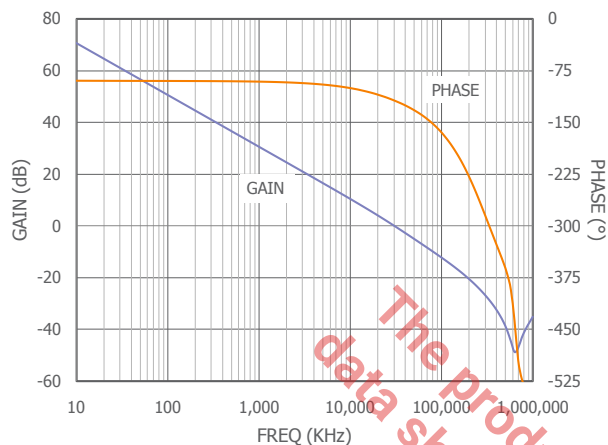

CMIR

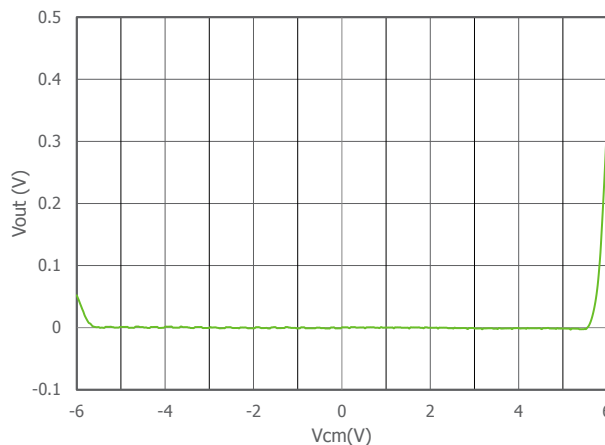

Input Voltage Noise

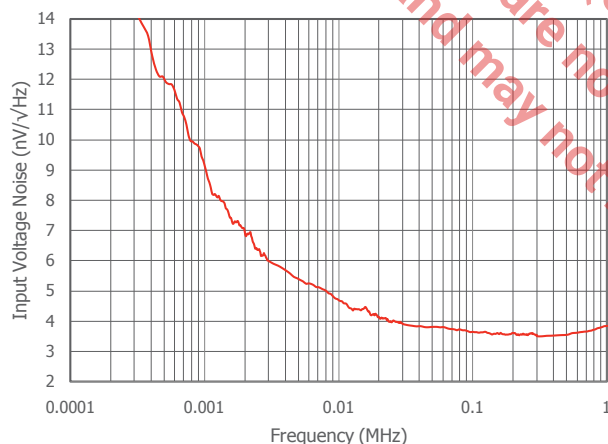

CMIR at $V_S = 3\text{V}$

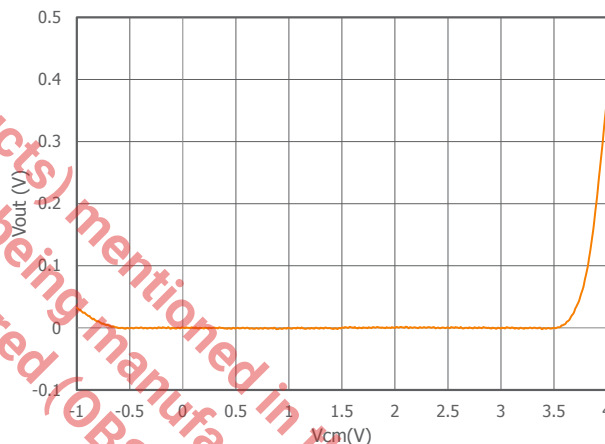

CMRR vs. Frequency

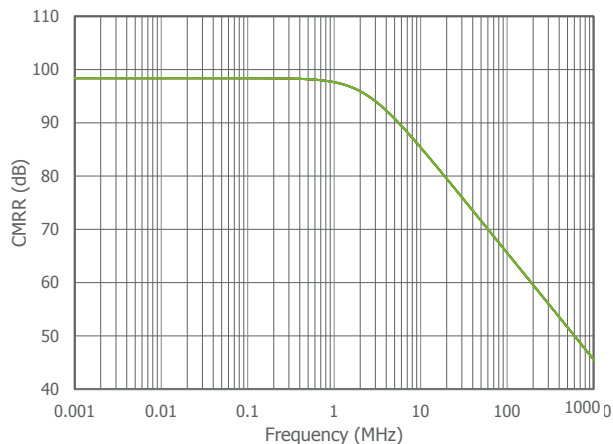

PSRR vs. Frequency

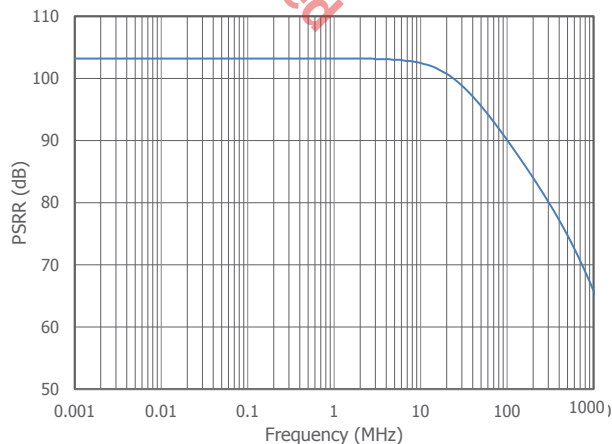

The product (or products) mentioned in this data sheet are no longer being manufactured (OBS) and may not be ordered.

Typical Performance Characteristics

$T_A = 25^\circ\text{C}$, $V_S = \pm 5\text{V}$, $R_f = 1\text{k}\Omega$, $R_L = 1\text{k}\Omega$, $G = 2$; unless otherwise noted.

2nd Harmonic Distortion vs. R_L

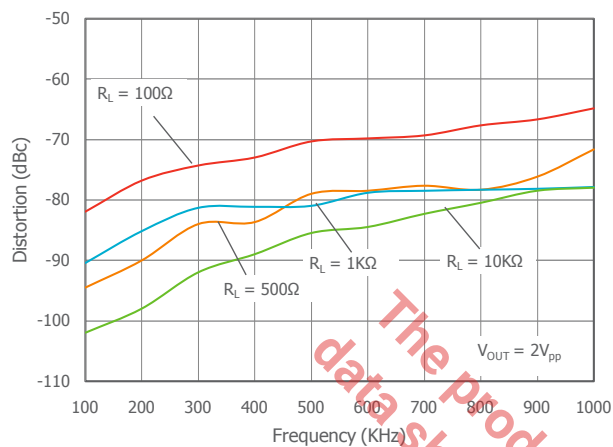

3rd Harmonic Distortion vs. R_L

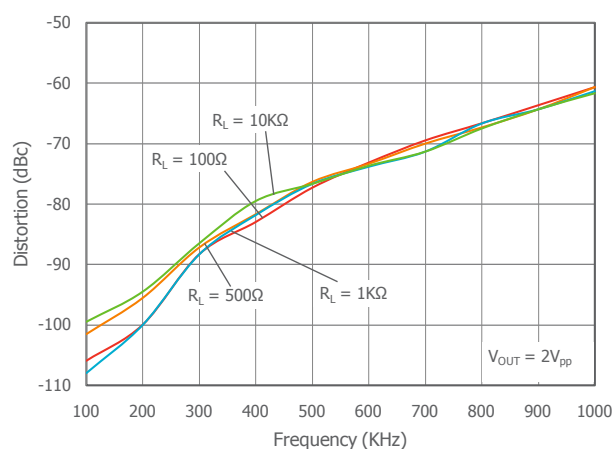

2nd Harmonic Distortion vs. V_{OUT}

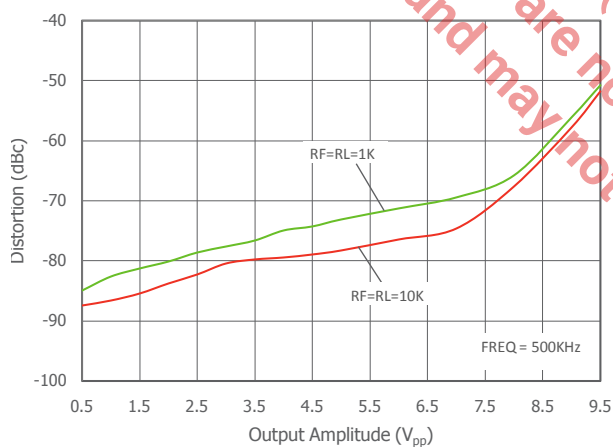

3rd Harmonic Distortion vs. V_{OUT}

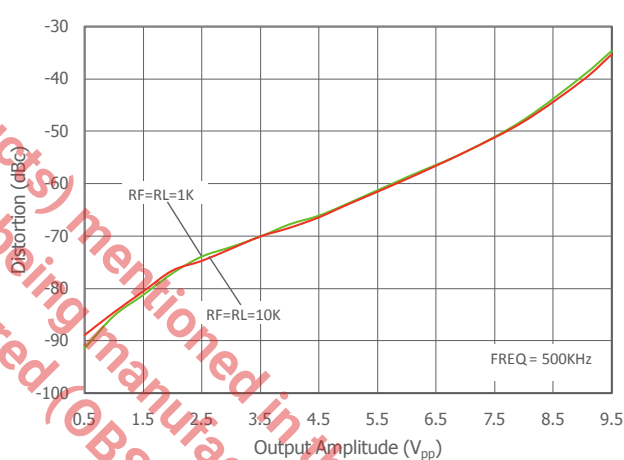

THD vs. Frequency

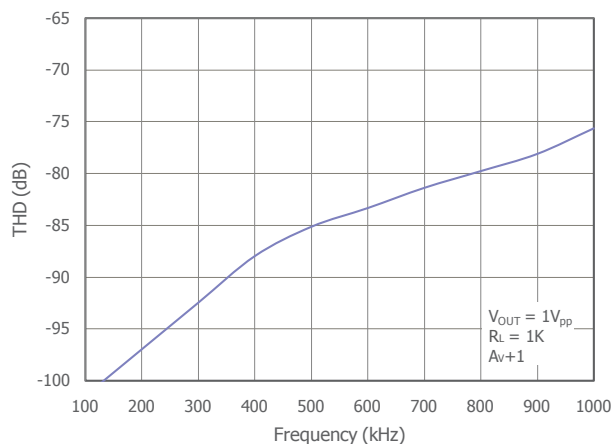

Typical Performance Characteristics

$T_A = 25^\circ\text{C}$, $V_S = \pm 5\text{V}$, $R_f = 1\text{k}\Omega$, $R_L = 1\text{k}\Omega$, $G = 2$; unless otherwise noted.

2nd Harmonic Distortion vs. R_L at $V_S = 3\text{V}$

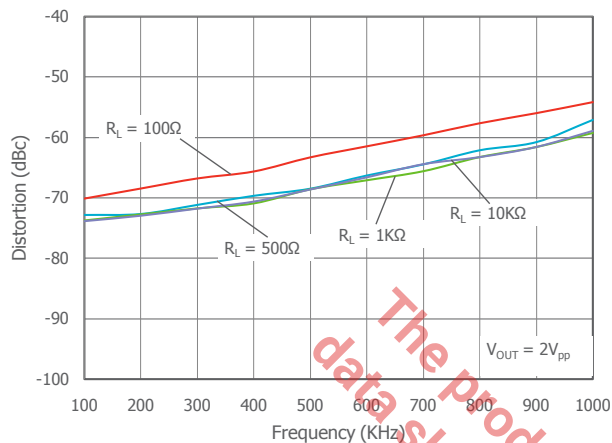

3rd Harmonic Distortion vs. R_L at $V_S = 3\text{V}$

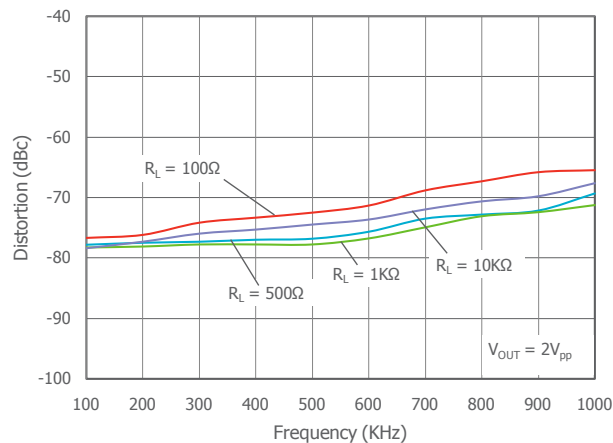

2nd Harmonic Distortion vs. V_{OUT} at $V_S = 3\text{V}$

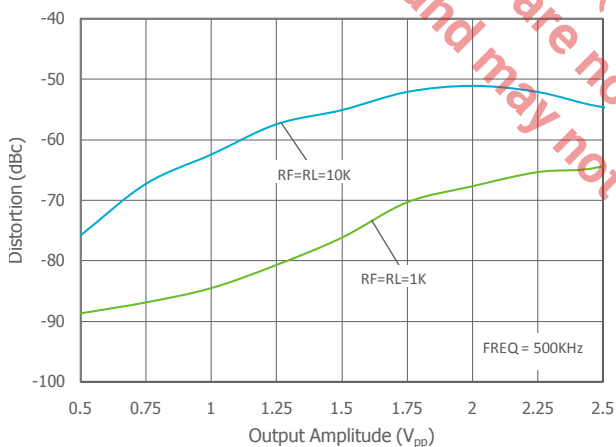

3rd Harmonic Distortion vs. V_{OUT} at $V_S = 3\text{V}$

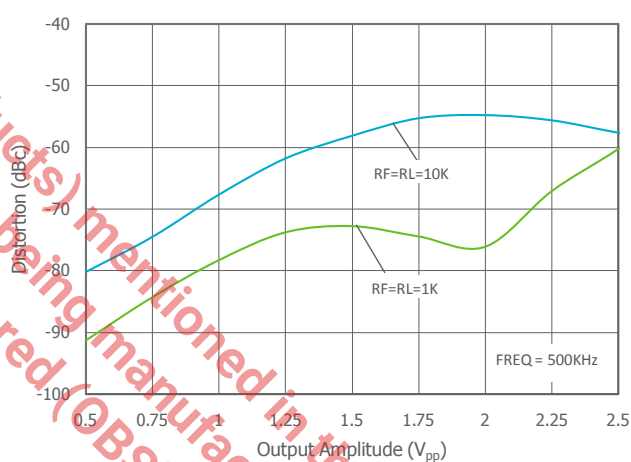

THD vs. Frequency at $V_S = 3\text{V}$

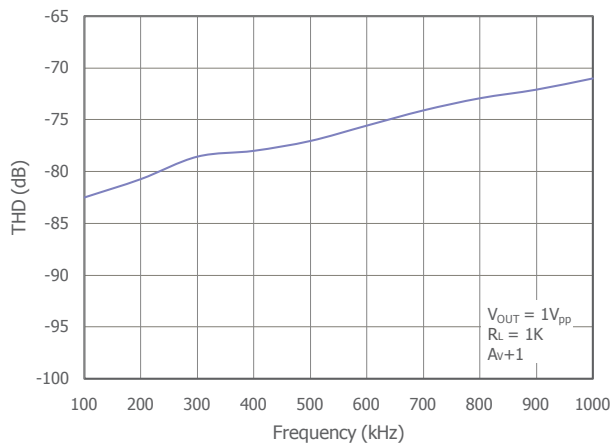

Typical Performance Characteristics

$T_A = 25^\circ\text{C}$, $V_S = \pm 5\text{V}$, $R_f = 1\text{k}\Omega$, $R_L = 1\text{k}\Omega$, $G = 2$; unless otherwise noted.

Small Signal Pulse Response

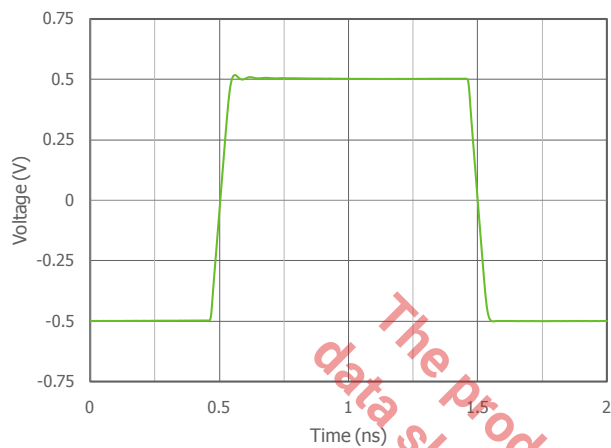

Small Signal Pulse Response at $V_S = 3\text{V}$

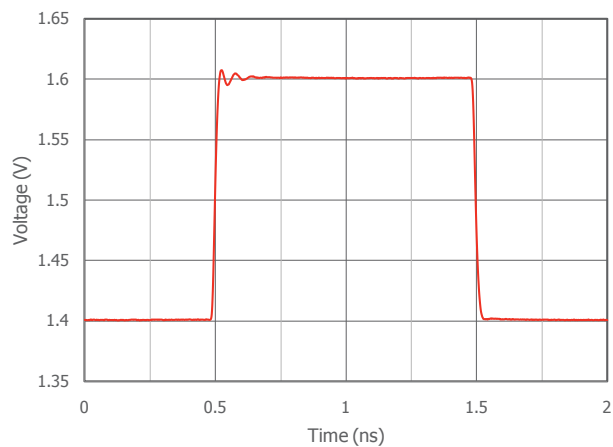

Large Signal Pulse Response

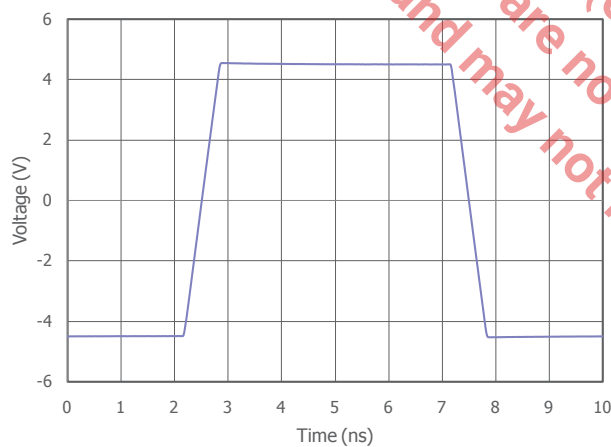

Large Signal Pulse Response at $V_S = 3\text{V}$

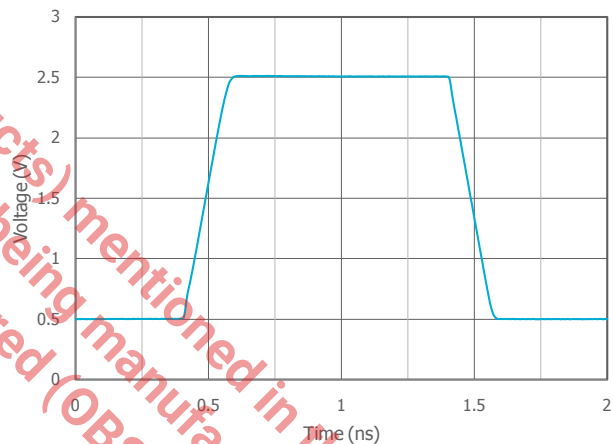

Application Information

Basic Information

Figures 1 and 2 illustrate typical circuit configurations for non-inverting, inverting, and unity gain topologies for dual supply applications. They show the recommended bypass capacitor values and overall closed loop gain equations.

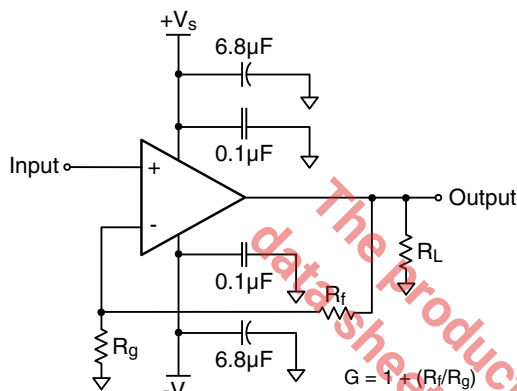

Figure 1: Typical Non-Inverting Gain Circuit

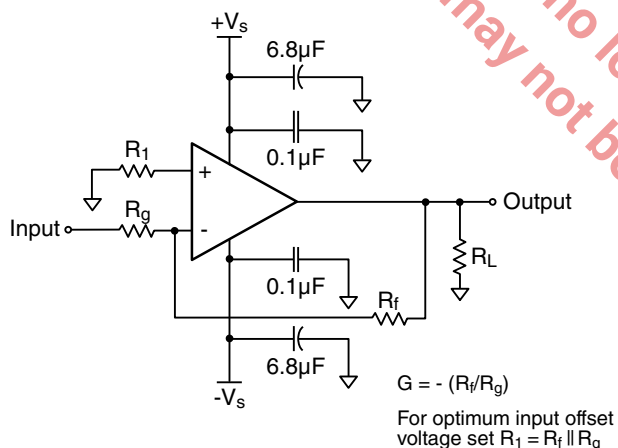

Figure 2: Typical Inverting Gain Circuit

Power Dissipation

Power dissipation should not be a factor when operating under the stated 500Ω load condition. However, applications with low impedance, DC coupled loads should be analyzed to ensure that maximum allowed junction temperature is not exceeded. Guidelines listed below can be used to verify that the particular application will not cause the device to operate beyond its intended operating range.

Maximum power levels are set by the absolute maximum junction rating of 150°C. To calculate the junction temperature, the package thermal resistance value θ_{JA} (θ_{JA}) is used along with the total die power dissipation.

$$T_{\text{Junction}} = T_{\text{Ambient}} + (\theta_{JA} \times P_D)$$

Where T_{Ambient} is the temperature of the working environment.

In order to determine P_D , the power dissipated in the load needs to be subtracted from the total power delivered by the supplies.

$$P_D = P_{\text{supply}} - P_{\text{load}}$$

Supply power is calculated by the standard power equation.

$$P_{\text{supply}} = V_{\text{supply}} \times I_{\text{RMSsupply}}$$

$$V_{\text{supply}} = V_{S+} - V_{S-}$$

Power delivered to a purely resistive load is:

$$P_{\text{load}} = ((V_{\text{load}})_{\text{RMS}}^2) / R_{\text{load_eff}}$$

The effective load resistor ($R_{\text{load_eff}}$) will need to include the effect of the feedback network. For instance,

$R_{\text{load_eff}}$ in Figure 2 would be calculated as:

$$R_L \parallel (R_f + R_g)$$

These measurements are basic and are relatively easy to perform with standard lab equipment. For design purposes however, prior knowledge of actual signal levels and load impedance is needed to determine the dissipated power. Here, P_D can be found from

$$P_D = P_{\text{Quiescent}} + P_{\text{Dynamic}} - P_{\text{load}}$$

Quiescent power can be derived from the specified I_S values along with known supply voltage, V_{supply} . Load power can be calculated as above with the desired signal amplitudes using:

$$(V_{\text{load}})_{\text{RMS}} = V_{\text{peak}} / \sqrt{2}$$

$$(I_{\text{load}})_{\text{RMS}} = (V_{\text{load}})_{\text{RMS}} / R_{\text{load_eff}}$$

The dynamic power is focused primarily within the output stage driving the load. This value can be calculated as:

$$P_{\text{Dynamic}} = (V_{S+} - V_{\text{load}})_{\text{RMS}} \times (I_{\text{load}})_{\text{RMS}}$$

Assuming the load is referenced in the middle of the power rails or $V_{\text{supply}}/2$.

Figure 3 shows the maximum safe power dissipation in the package vs. the ambient temperature for the packages available.

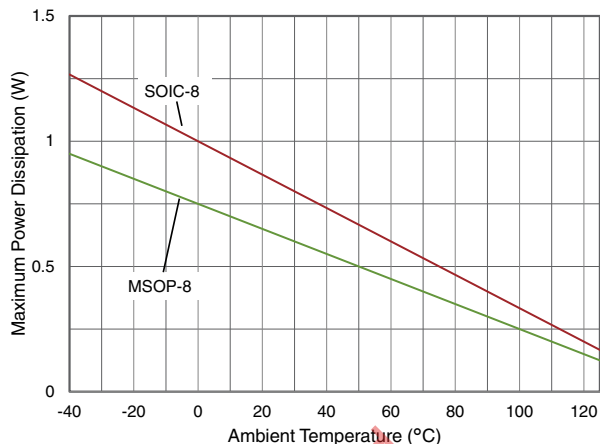

Figure 3. Maximum Power Derating

Driving Capacitive Loads

Increased phase delay at the output due to capacitive loading can cause ringing, peaking in the frequency response, and possible unstable behavior. Use a series resistance, R_S , between the amplifier and the load to help improve stability and settling performance. Refer to Figure 4.

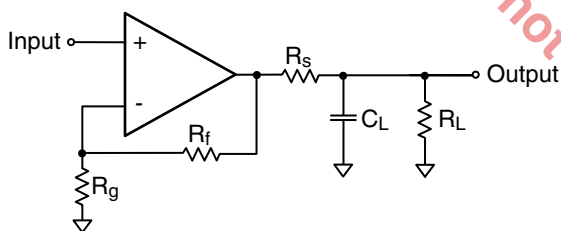

Figure 4. Addition of R_S for Driving Capacitive Loads

The CLC2023 is capable of driving up to 300pF directly, with no series resistance. Directly driving 500pF causes over 4dB of frequency peaking, as shown in the plot on page 6. Table 1 provides the recommended R_S for various capacitive loads. The recommended R_S values result in ≤ 1 dB peaking in the frequency response. The Frequency Response vs. C_L plots, on page 6, illustrate the response of the CLC2023.

C_L (pF)	R_S (Ω)	-3dB BW (MHz)
500	10	27
1000	7.5	20
3000	4	15

Table 1: Recommended R_S vs. C_L

For a given load capacitance, adjust R_S to optimize the tradeoff between settling time and bandwidth. In general, reducing R_S will increase bandwidth at the expense of additional overshoot and ringing.

Overdrive Recovery

An overdrive condition is defined as the point when either one of the inputs or the output exceed their specified voltage range. Overdrive recovery is the time needed for the amplifier to return to its normal or linear operating point. The recovery time varies based on whether the input or output is overdriven and by how much the ranges are exceeded. The CLC2023 will typically recover in less than 20ns from an overdrive condition. Figure 5 shows the CLC2023 in an overdriven condition.

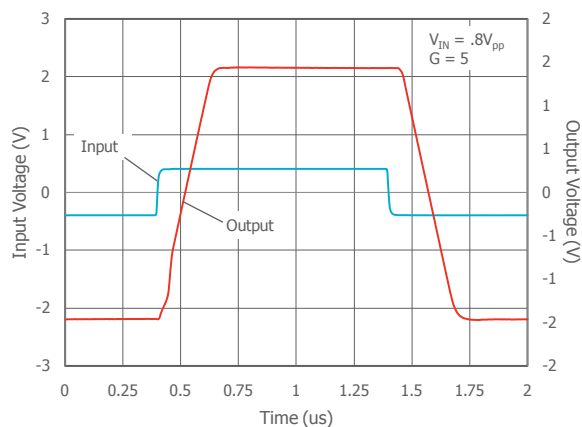

Figure 5: Overdrive Recovery

Considerations for Offset and Noise Performance

Offset Analysis

There are three sources of offset contribution to consider; input bias current, input bias current mismatch, and input offset voltage. The input bias currents are assumed to be equal with an additional offset current in one of the inputs to account for mismatch. The bias currents will not affect the offset as long as the parallel combination of R_f and R_g matches R_t . Refer to Figure 6.

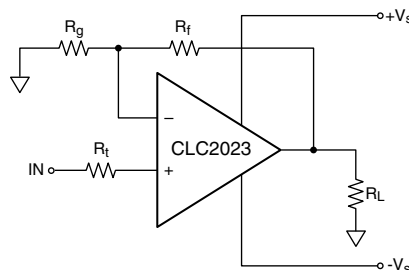

Figure 6: Circuit for Evaluating Offset

The first place to start is to determine the source resistance. If it is very small an additional resistance may need to be added to keep the values of R_f and R_g to practical levels. For this analysis we assume that R_t is the total resistance present on the non-inverting input. This gives us one equation that we must solve:

$$R_t = R_g \parallel R_f$$

This equation can be rearranged to solve for R_g :

$$R_g = (R_t * R_f) / (R_f - R_t)$$

The other consideration is desired gain (G) which is:

$$G = (1 + R_f/R_g)$$

By plugging in the value for R_g we get

$$R_f = G * R_t$$

And R_g can be written in terms of R_t and G as follows:

$$R_g = (G * R_t) / (G - 1)$$

The complete input offset equation is now only dependent on the voltage offset and input offset terms given by:

$$V_{IOS} = \sqrt{(V_{IO})^2 + (I_{OS} * RT)^2}$$

And the output offset is:

$$V_{OOS} = G * \sqrt{(V_{IO})^2 + (I_{OS} * RT)^2}$$

Noise analysis

The complete equivalent noise circuit is shown in Figure 7.

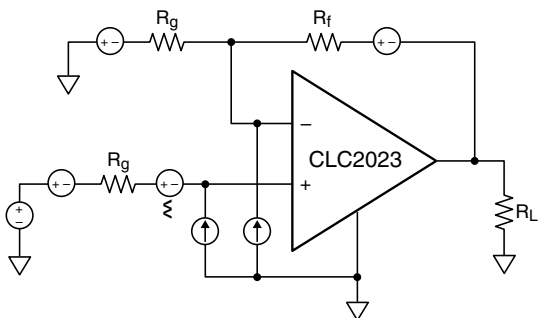

Figure 7: Complete Equivalent Noise Circuit

The complete noise equation is given by:

$$v_o^2 = v_{orext}^2 + \left(e_n \left(1 + \frac{R_f}{R_g} \right) \right)^2 + \left(i_{bp} * RT \left(1 + \frac{R_f}{R_g} \right) \right)^2 + \left(i_{bn} * R_f \right)^2$$

Where V_{orext} is the noise due to the external resistors and is given by:

$$v_o^2 = \left(e_n \left(1 + \frac{R_f}{R_g} \right) \right)^2 + \left(e_G * \frac{R_f}{R_g} \right)^2 + e_F^2$$

The complete equation can be simplified to:

$$v_o^2 = 3 * (4kT * G * RT) + (e_n G)^2 + 2 * (i_n * RT)^2$$

It's easy to see that the effect of amplifier voltage noise is proportionate to gain and will tend to dominate at large gains. The other terms will have their greatest impact at large R_t values at lower gains.

Layout Considerations

General layout and supply bypassing play major roles in high frequency performance. Exar has evaluation boards to use as a guide for high frequency layout and as an aid in device testing and characterization. Follow the steps below as a basis for high frequency layout:

- Include 6.8μF and 0.1μF ceramic capacitors for power supply decoupling
- Place the 6.8μF capacitor within 0.75 inches of the power pin
- Place the 0.1μF capacitor within 0.1 inches of the power pin
- Remove the ground plane under and around the part, especially near the input and output pins to reduce parasitic capacitance
- Minimize all trace lengths to reduce series inductances

Refer to the evaluation board layouts below for more information.

Evaluation Board Information

The following evaluation boards are available to aid in the testing and layout of these devices:

Evaluation Board #	Products
CEB006	CLC2023 in SOIC-8
CEB010	CLC2023 in MSOP-8

Evaluation Board Schematics

Evaluation board schematics and layouts are shown in Figures 8-12. These evaluation boards are built for dual-supply operation. Follow these steps to use the board in a single-supply application:

1. Short $-V_S$ to ground.
2. Use C3 and C4, if the $-V_S$ pin of the amplifier is not directly connected to the ground plane.

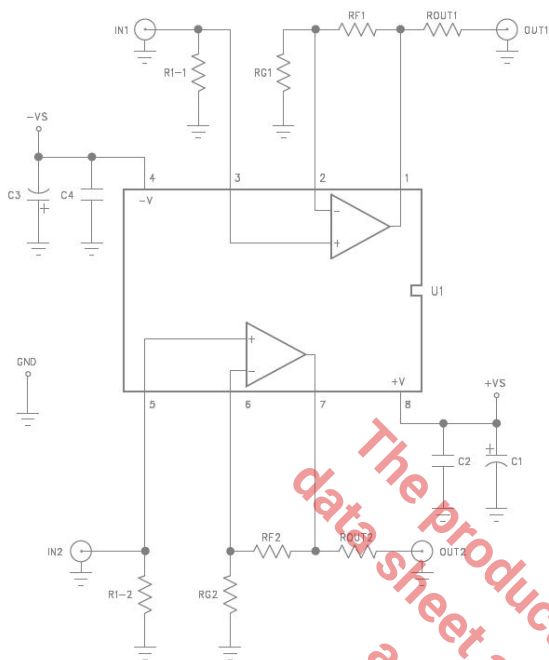

Figure 8. CEB006 & CEB010 Schematic

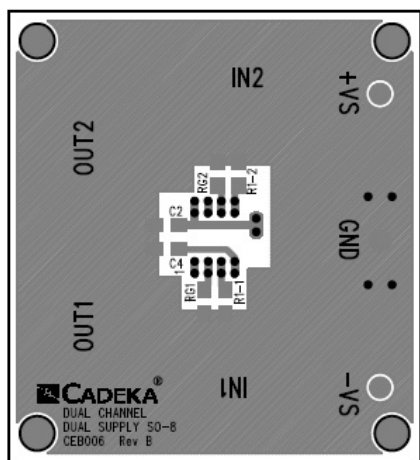

Figure 9. CEB006 Top View

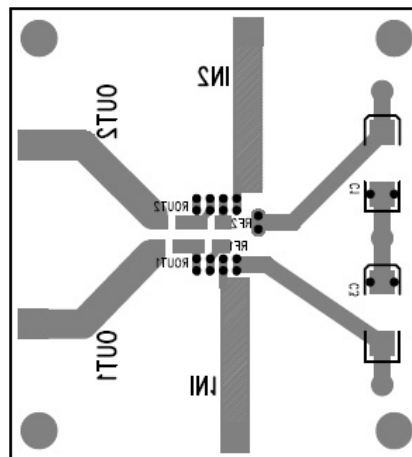

Figure 10. CEB006 Bottom View

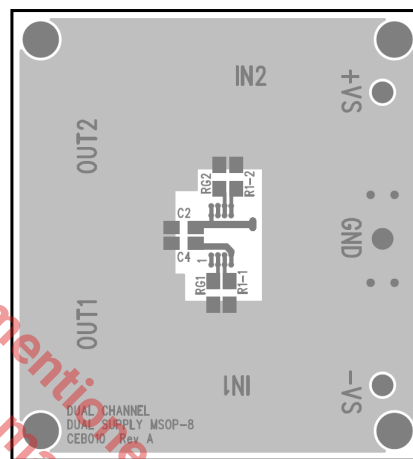

Figure 11. CEB010 Top View

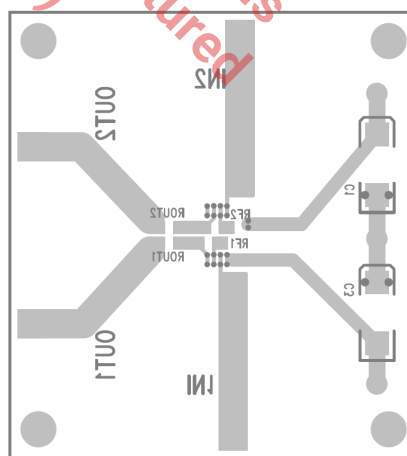
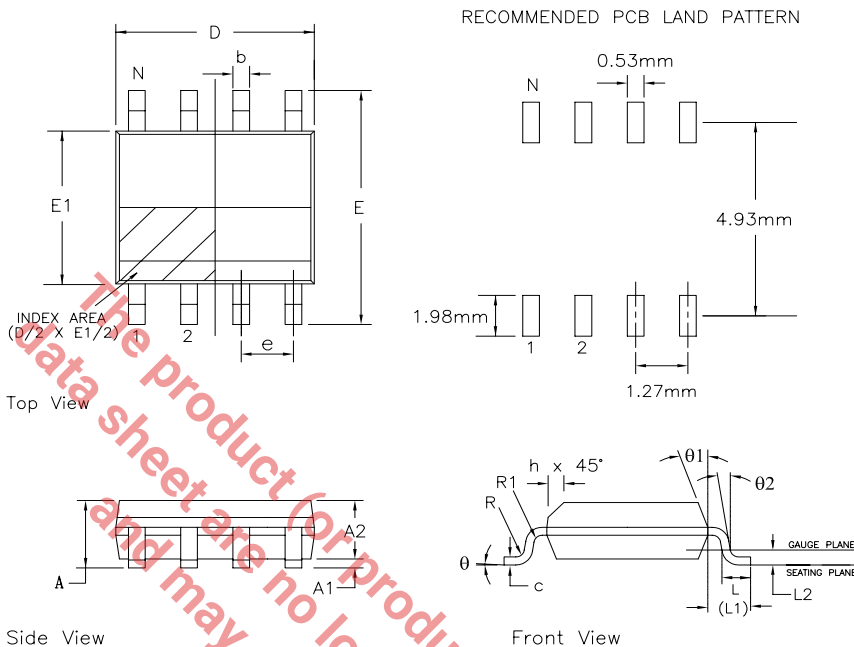

Figure 12. CEB010 Bottom View

Mechanical Dimensions

SOIC-8 Package



SYMBOLS	DIMENSIONS IN MM (Control Unit)			DIMENSIONS IN INCH (Reference Unit)		
	MIN	NOM	MAX	MIN	NOM	MAX
A	1.35	—	1.75	0.053	—	0.069
A1	0.10	—	0.25	0.004	—	0.010
A2	1.25	—	1.65	0.049	—	0.065
b	0.51	—	0.51	0.012	—	0.020
c	0.17	—	0.25	0.007	—	0.010
E	6.00 BSC			0.236 BSC		
E1	3.90 BSC			0.154 BSC		
e	1.27 BSC			0.050 BSC		
h	0.25	—	0.50	0.010	—	0.020
L	0.40	—	1.27	0.016	—	0.050
L1	0.04	REF	—	0.041	REF	—
L2	0.25	BSC	—	0.010	BSC	—
R	0.07	—	—	0.003	—	—
R1	0.07	—	—	0.003	—	—
θ	0°	—	8°	0°	—	8°
θ1	5°	—	15°	5°	—	15°
θ2	0°	—	—	0°	—	—
D	4.90 BSC			0.193 BSC		
N	8			8		

MSOP-8 Package

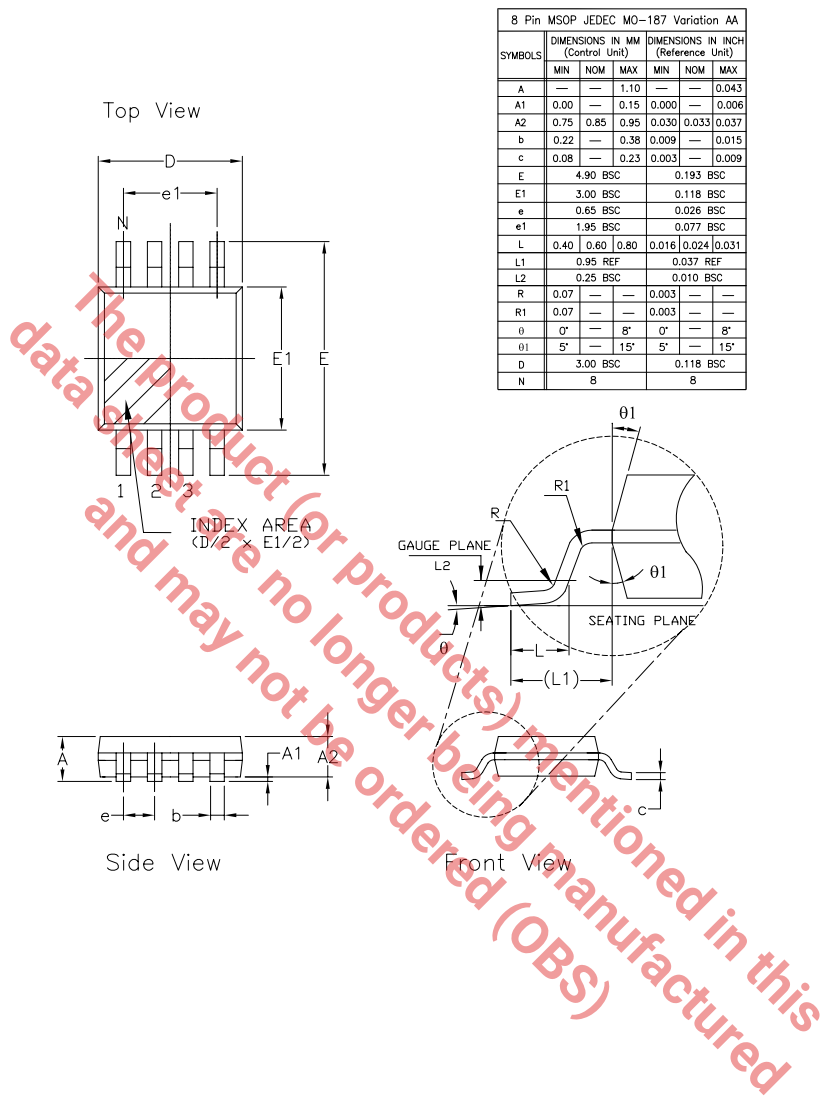

Ordering Information

Part Number	Package	Green	Operating Temperature Range	Packaging
CLC2023 Ordering Information				
CLC2023IMP8X	MSOP-8	Yes	-40°C to +125°C	Tape & Reel
CLC2023IMP8MTR	MSOP-8	Yes	-40°C to +125°C	Mini Tape & Reel
CLC2023IMP8EVB	Evaluation Board	N/A	N/A	N/A
CLC2023ISO8X	SOIC-8	Yes	-40°C to +125°C	Tape & Reel
CLC2023ISO8MTR	SOIC-8	Yes	-40°C to +125°C	Mini Tape & Reel
CLC2023ISO8EVB	Evaluation Board	N/A	N/A	N/A

Moisture sensitivity level for all parts is MSL-1.

Revision History

Revision	Date	Description
1D (ECN 1451-06)	December 2014	Reformat into Exar data sheet template. Updated ordering information table to include MTR and EVB part numbers. Increased "I" temperature range from +85 to +125°C. Removed "A" temp grade parts, since "I" is now equivalent. Updated thermal resistance numbers and package outline drawings.

For Further Assistance:

Email: CustomerSupport@exar.com or HPATechSupport@exar.com

Exar Technical Documentation: <http://www.exar.com/techdoc/>

Exar Corporation Headquarters and Sales Offices

48760 Kato Road
Fremont, CA 94538 - USA

Tel.: +1 (510) 668-7000
Fax: +1 (510) 668-7001



A New Direction in Mixed-Signal

NOTICE

EXAR Corporation reserves the right to make changes to the products contained in this publication in order to improve design, performance or reliability. EXAR Corporation assumes no responsibility for the use of any circuits described herein, conveys no license under any patent or other right, and makes no representation that the circuits are free of patent infringement. Charts and schedules contained here in are only for illustration purposes and may vary depending upon a user's specific application. While the information in this publication has been carefully checked; no responsibility, however, is assumed for inaccuracies.

EXAR Corporation does not recommend the use of any of its products in life support applications where the failure or malfunction of the product can reasonably be expected to cause failure of the life support system or to significantly affect its safety or effectiveness. Products are not authorized for use in such applications unless EXAR Corporation receives, in writing, assurances to its satisfaction that: (a) the risk of injury or damage has been minimized; (b) the user assumes all such risks; (c) potential liability of EXAR Corporation is adequately protected under the circumstances.

Reproduction, in part or whole, without the prior written consent of EXAR Corporation is prohibited.